

2021

BELLA
15 años iluminando

catálogo

Índice

LANÇAMENTOS

Abaporu	96	Fuxico	62
Balango	90	Ginga	6
Bambolê	32	Graviola	12
Bambu	102	Halo	58
Bem-Te-Vi	94	Hex	52
Birdie	24	Lindo	79
Birdie Oval	24	Loop	26
Caê	95	Maison	110
Caju	106	Mantra	66
Calder	88	Nébula	15
Cálix	69	Oca	48
Candy	61	Oggi	70
Colméia	14	Órbita	34
Coralina	72	Petit Poa	73
Cuica	100	Pingo	86
Factory	80	Pituco	20
Fato	55	Tec	36
Fog	56	Titia	81
Friso	10		

DOWNLIGHT

Acessório	372
Basic	335
Beam	354
Conecta	345
Ecco	349
Low Frame	367
Neo	350
NewSmart	369
Pharos	356
Tampa Cega	362
Trilhos	358

LEDPRO

Acessório	388
Driver	385
Fitas	380
Lâmpadas	374

DECORATIVO

Anita	321	Disegno	322	Lettura	304	Prism	215
Anjou	192	Drop	273	Litho	331	Ravel	306
Ares	270	Éle	303	Long	215	Rio	257
Arpejo	211	Elysee	195	Malagueta	229	Samba	230
Asta	243	Espelho	319	Marmo	324	Sansa	216
Athena	270	Eze	211	Mini	334	Scent	327
Baju	328	Filó	248	Mob	234	Scope	289
Bar	297	Fiore	208	Móbile	237	Shine	307
Bell	307	Flora	212	Mol	237	Skopo	272
Bells	214	Floresta	220	Monde	323	Soho	258
Bocci	250	Foglia	200	Motif	322	Speculo	244
Cacau	217	Fuocco	294	Naif	328	Spider	272
Cage	281	Gallery	196	Neo	236	Tahi	227
Caiena	226	Gamboa	245	Nickel	310	Tarsila	321
Canela	222	Glaze	305	Nix	229	Than	244
Canjica	275	Goutte	211	Nut	209	Theo	332
Carlota	223	Guarana	238	Odeon	199	Telinha	311
Charm	205	Guri	246	Orbe	252	Tratto	282
Clap	283	Hera	201	Organika	265	Três	240
Classic	325	Ibira	218	Oro	280	Tyene	198
Concret	294	Indian	210	Oscar	221	Veneto	312
Cone	242	Ipanema	266	Oxala	224	Vinha	228
Copper	276	Khao	245	Palace	201	Vitti	256
Cotton	274	Kri	202	Paris	199	Viva	82
Crily	329	Lamp	278	Passy	197	Vivi	200
Di	320	Lamparina	232	Pin	283	Wood	284
Dijon	206	Lan	288	Pipe	286		
Dio	273	Leblon	268	Pliss	334		
Disc	311	Lêra	303	Prih	271		

15 anos iluminando

A Bella Iluminação nasce em 2006 em São Paulo com o objetivo de desenvolver, importar e distribuir luminárias decorativas, sempre em sintonia com as principais tendências mundiais de design e iluminação.

Com o passar dos anos, fortalecemos a nossa marca em todo território nacional e nos posicionamos ao lado dos principais líderes de mercado importadores de iluminação do país.

Participamos de forma atuante dos principais eventos do setor e estamos presentes nas maiores lojas especializadas do Brasil, proporcionando aos nossos parceiros comerciais excelentes oportunidades de negócio.

Na busca incessante por melhoria de qualidade e tecnologia da nossa extensa linha de produtos, retomamos, em 2021, o desenvolvimento das nossas categorias DownLight e LedPro, provando mais uma vez o nosso compromisso com o nosso parceiro em oferecer as mais completas soluções em iluminação técnica e decorativa.

Temos muito orgulho da nossa história e só podemos agradecer a todos que confiaram em nossos sonhos e estiveram conosco durante esses 15 anos.

Iluminação Que Transforma

Lançamentos

Ginga



lançamentos

Pendente
Ginga

BB024

Material: aço, alumínio e acrílico
Cor: french gold
Tensão: Bivolt
Potência: 1X33W (33W)
Soquete: LED
Medida: 17cm x 105cm x 17cm
Temperatura de cor: 3000K
Fluxo luminoso: 1470lm

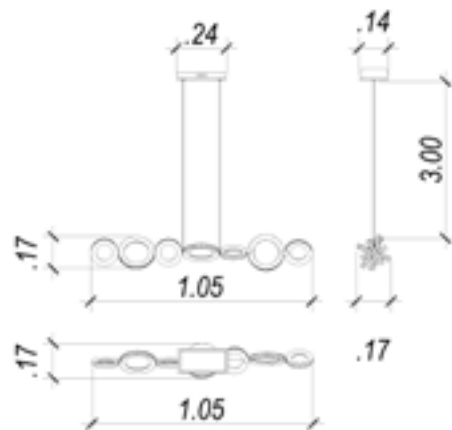

Pendente

Ginga

BB023

Material: aço, alumínio e acrílico
Cor: french gold
Tensão: Bivolt
Potência: 2X5W (10W)
Soquete: LED
Medida: ø17cm x 30cm
Temperatura de cor: 3000K
Fluxo luminoso: 420lm

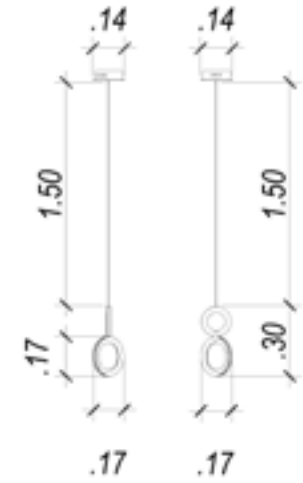

lançamentos

lançamentos



Arandela

Ginga

BB025

Material: aço, alumínio e acrílico
Cor: french gold
Tensão: Bivolt
Potência: 1X6W (6W)
Soquete: LED
Medida: ø17cm x 10,5cm x 17cm
Temperatura de cor: 3000K
Fluxo luminoso: 300lm

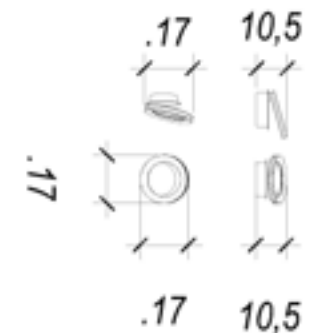

Pendente
Ginga
BB011

Material: aço alumínio e acrílico
Cor: rose gold e preto
Tensão: bivolt
Potência: 2X 4,3W + 3 X 6,1W (26,9W)
Soquete: LED
Medida: 85cm x 19cm x 24,5cm
Temperatura de cor: 3000K
Fluxo luminoso: 1345lm

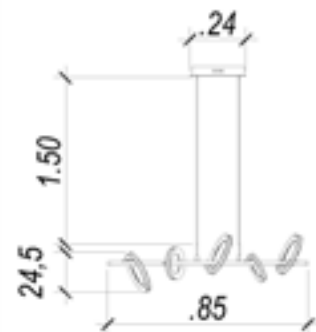

Abajur
Ginga
BB013

Material: aço alumínio e acrílico
Cor: rose gold e preto
Tensão: bivolt
Potência: 4,3W + 6,1W (10,4W)
Soquete: LED
Medida: Ø20cm x 60cm
Temperatura de cor: 3000K
Fluxo luminoso: 520lm

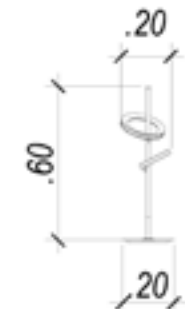

Pendente
Ginga
BB012

Material: aço alumínio e acrílico
Cor: rose gold e preto
Tensão: bivolt
Potência: 2X 4,3W + 3X 6,1W (16,5W)
Soquete: LED
Medida: Ø23,5cm x (a) 52cm
Temperatura de cor: 3000K
Fluxo luminoso: 825lm



Arandela
Ginga
BB010

Material: aço alumínio e acrílico
Cor: rose gold e preto
Tensão: bivolt
Potência: 2X 4,3W (8,6W)
Soquete: LED
Medida: 37cm x 17cm x 16cm
Temperatura de cor: 3000K
Fluxo luminoso: 430lm

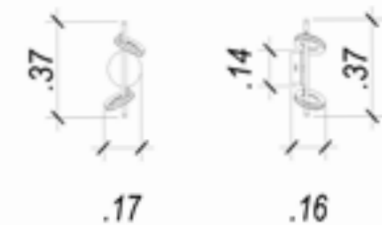

Arandela
Ginga
BB015

Material: aço alumínio e acrílico
Cor: rose gold e preto
Tensão: bivolt
Potência: 1X 6W
Soquete: LED
Medida: 10,5cm x (c) 17cm x (a) 17cm
Temperatura de cor: 3000K
Fluxo luminoso: 300lm

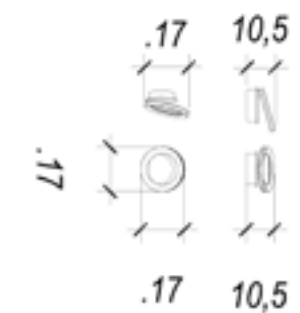



Friso



Pendente
Friso
BD005

Material: metal e acrílico
Cor: dourado e transparente
Tensão: Bivolt
Potência: 1X30W (30W)
Soquete: LED
Medida: ø52cm
Temperatura de cor: 3000K
Fluxo luminoso: 1500lm

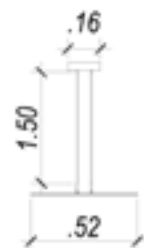
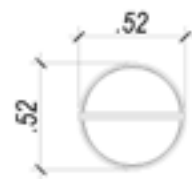

Pendente
Friso
BD006

Material: metal e acrílico
Cor: dourado e transparente
Tensão: Bivolt
Potência: 1X35W (35W)
Soquete: LED
Medida: ø66cm
Temperatura de cor: 3000K
Fluxo luminoso: 1750lm

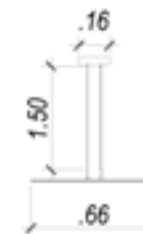
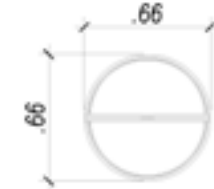

Arandela / Plafon
Friso
BD007

Material: metal e acrílico
Cor: dourado e transparente
Tensão: Bivolt
Potência: 1X30W (30W)
Soquete: LED
Medida: 6,8cm x 15cm x 52cm
Temperatura de cor: 3000K
Fluxo luminoso: 1500lm

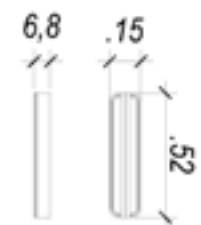

Graviola

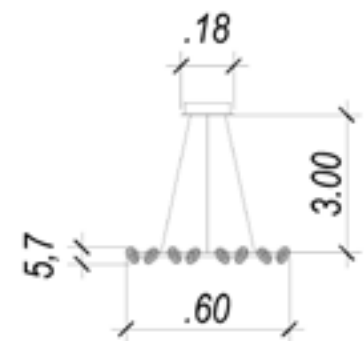

Pendente
Graviola
DS001

Material: metal e acrílico
Cor: dourado preto e branco
Tensão: Bivolt
Potência: 16X3W (48W)
Soquete: LED
Medida: ø60cm x 5,7cm
Temperatura de cor: 3000K
Fluxo luminoso: 2640lm



Pendente
Graviola
DS002

Material: metal e acrílico
Cor: dourado preto e branco
Tensão: Bivolt
Potência: 12X3W (36W)
Soquete: LED
Medida: 102cm x 5,7cm
Temperatura de cor: 3000K
Fluxo luminoso: 1980lm

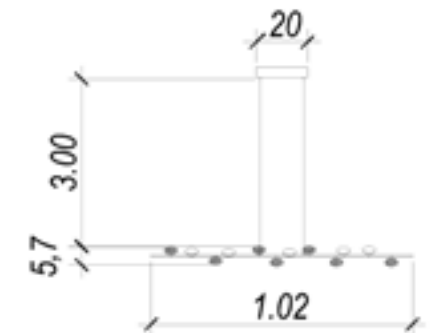

Arandela
Graviola
DS003

Material: metal e acrílico
Cor: dourado preto e branco
Tensão: Bivolt
Potência: 3X3W (9W)
Soquete: LED
Medida: ø13cm x 45cm
Temperatura de cor: 3000K
Fluxo luminoso: 495lm





Colméia

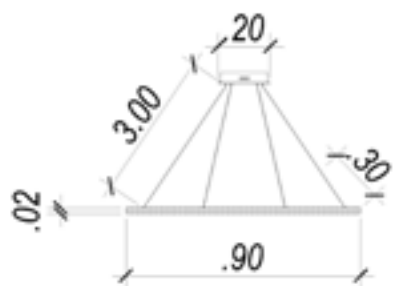

Pendente
Colméia
DW001

Material: metal e cristal
Cor: cromado e champanhe
Tensão: Bivolt
Potência: 1X54W (54W)
Soquete: LED
Medida: 30cm x 90cm
Temperatura de cor: 3000K
Fluxo luminoso: 2700lm

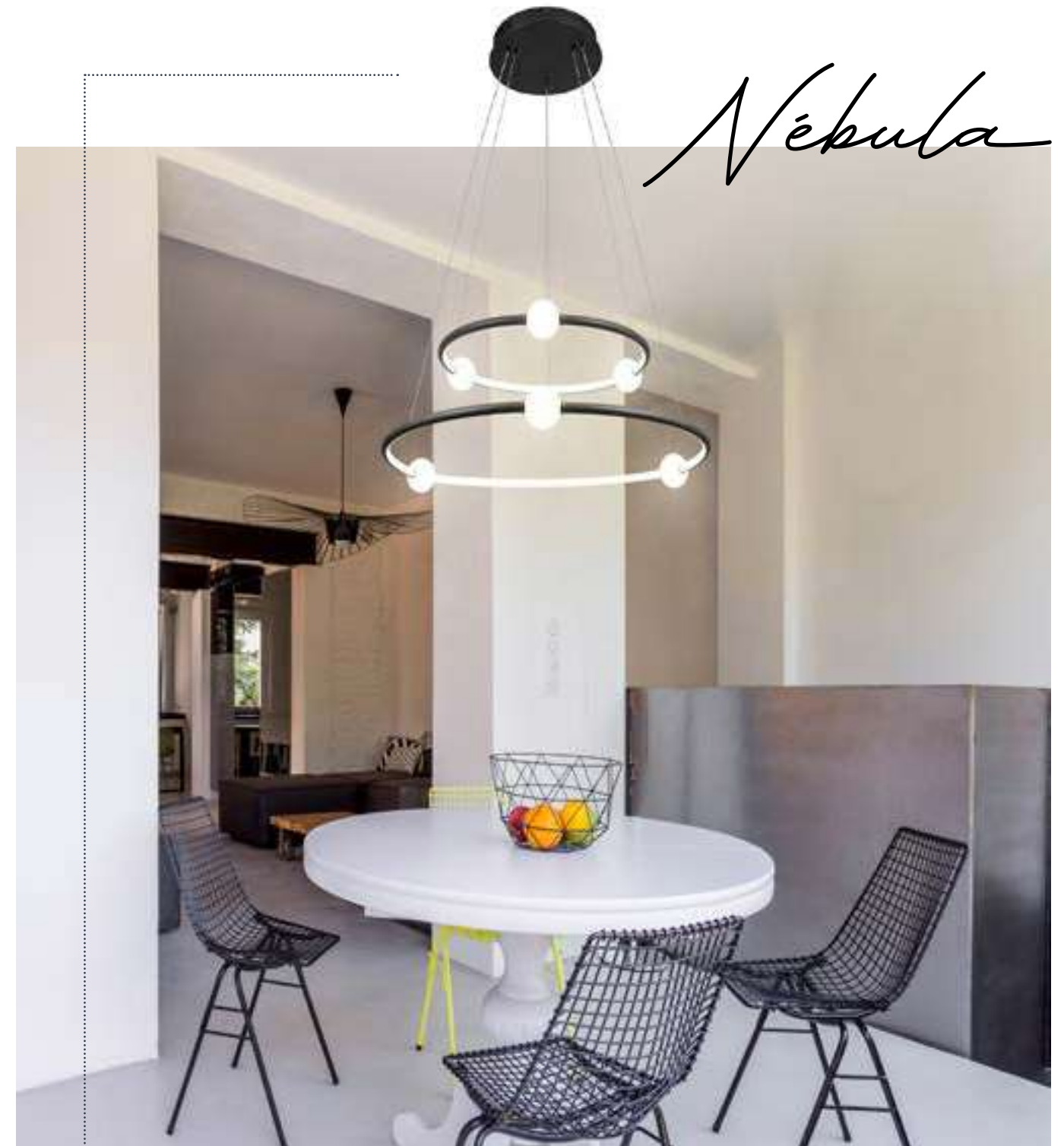

Nébulas

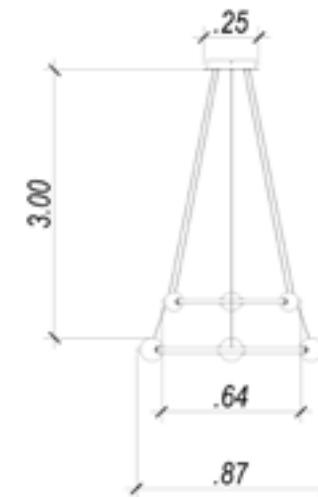

Pendente
Nébulas
DW005LB

Material: metal e vidro
Cor: preto e branco
Tensão: Bivolt
Potência: 1X80W (80W)
Soquete: LED
Medida: ø87cm e ø64cm
Temperatura de cor: 3000K
Fluxo luminoso: 4000lm



Pendente
Nebula
DW005LG

Material: metal e vidro
Cor: dourado e branco
Tensão: Bivolt
Potência: 1X80W (80W)
Soquete: LED
Medida: ø87cm e ø64cm
Temperatura de cor: 3000K
Fluxo luminoso: 4000lm

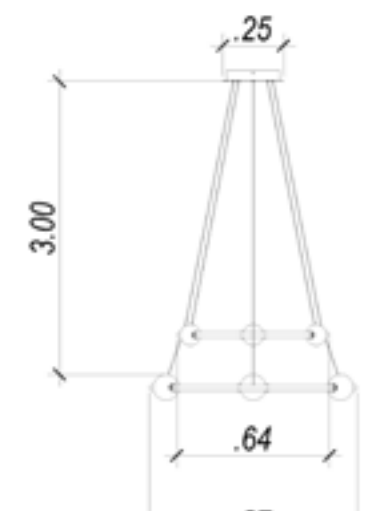

Pendente
Nebula
DW005SB

Material: metal e vidro
Cor: preto e branco
Tensão: Bivolt
Potência: 1X35W (35W)
Soquete: LED
Medida: ø87cm
Temperatura de cor: 3000K
Fluxo luminoso: 1750lm

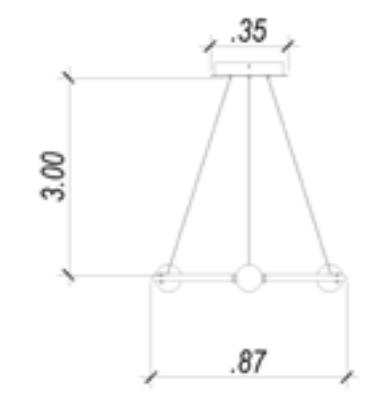

Pendente
Nebula
DW005SG

Material: metal e vidro
Cor: dourado e branco
Tensão: Bivolt
Potência: 1X35W (35W)
Soquete: LED
Medida: ø87cm
Temperatura de cor: 3000K
Fluxo luminoso: 1750lm

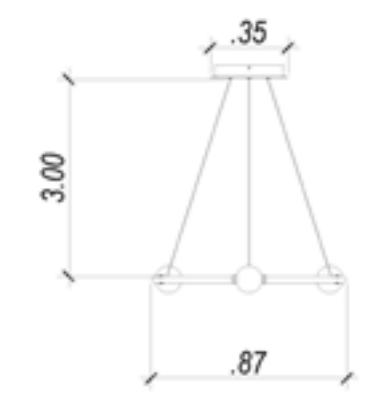



Pendente

Nebula

DW006B

Material: metal e vidro
Cor: preto e branco
Tensão: Bivolt
Potência: 1X42W (42W)
Soquete: LED
Medida: 28cm x 105cm
Temperatura de cor: 3000K
Fluxo luminoso: 2100lm

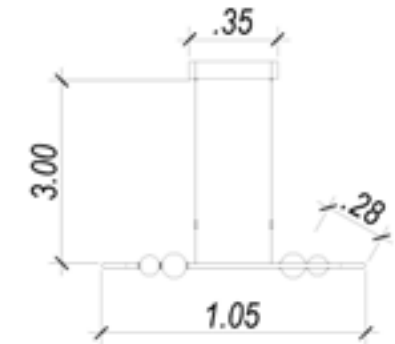

Pendente

Nebula

DW006G

Material: metal e vidro
Cor: dourado e branco
Tensão: Bivolt
Potência: 1X42W (42W)
Soquete: LED
Medida: 28cm x 105
Temperatura de cor: 3000K
Fluxo luminoso: 2100lm

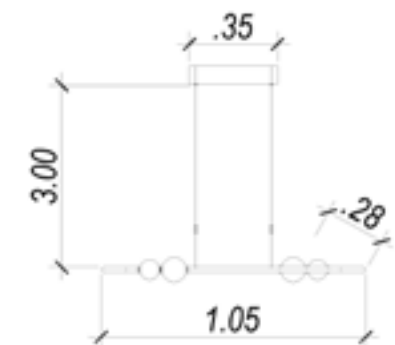

Pituco

lançamentos

Pendente
Pituco
ML016GB

Material: metal
Cor: preto e dourado
Tensão: Bivolt
Potência: 1X10W (10W)
Soquete: GU10
Lâmpada: MR16
Medida: ø9cm x 26cm



Pendente
Pituco
ML016GW

Material: metal
Cor: branco e dourado
Tensão: Bivolt
Potência: 1X10W (10W)
Soquete: GU10
Lâmpada: MR16
Medida: ø9cm x 26cm



lançamentos

Pendente
Pituco
ML015GB

Material: metal
Cor: preto e dourado
Tensão: Bivolt
Potência: 1X10W (10W)
Soquete: GU10
Lâmpada: MR16
Medida: ø10cm x 18,7cm



Pendente
Pituco
ML015GW

Material: metal
Cor: branco e dourado
Tensão: Bivolt
Potência: 1X10W (10W)
Soquete: GU10
Lâmpada: MR16
Medida: ø10cm x 18,7cm



lançamentos



PENDENTE
Pépeto
MLO16W
Material: metal
Cor: rose gold e branco
Tensão: bivolt
Potência: 1X10W
Soquete: GU10
Lâmpada: MR16
Medida: Ø9cmx26cm

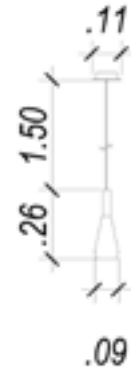

PENDENTE
Pépeto
MLO15W
Material: metal
Cor: rose gold e branco
Tensão: bivolt
Potência: 1X10W
Soquete: GU10
Lâmpada: MR16
Medida: Ø10cmx18.7cm

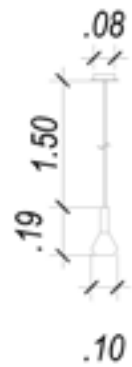

PENDENTE
Pépeto
MLO16B
Material: metal
Cor: rose gold e preto
Tensão: bivolt
Potência: 1X10W
Soquete: GU10
Lâmpada: MR16
Medida: Ø9cmx26cm

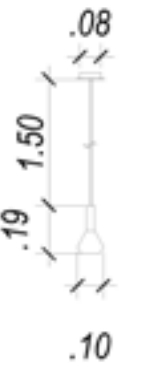
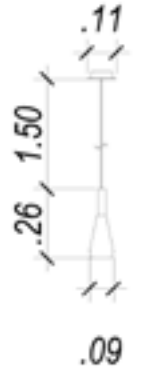

PENDENTE
Pépeto
MLO15B
Material: metal
Cor: rose gold e preto
Tensão: bivolt
Potência: 1X10W
Soquete: GU10
Lâmpada: MR16
Medida: Ø10cmx18.7cm



Birdie

lançamentos

Pendente

Birdie Oval

KW004G

Material: metal
Cor: dourado
Tensão: Bivolt
Potência: 17W +13W +9W (39W)
Soquete: LED
Medida: ø80cm + ø50cm + 42cm
Temperatura de cor: 3200K
Fluxo luminoso: 3120lm



lançamentos



Pendente

Birdie

KW002B

Material: metal
Cor: preto
Tensão: Bivolt
Potência: 17W +13W +9W (39W)
Soquete: LED
Medida: ø80cm + 42cm
Temperatura de cor: 3200K
Fluxo luminoso: 3120lm

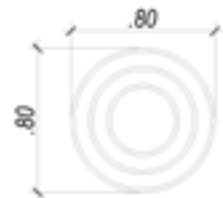

Pendente

Birdie

KW002E

Material: metal e silicone
Cor: rose gold e branco
Tensão: bivolt
Potência: 17W +13W +9W (39W)
Soquete: LED
Medida: ø80cm + 42cm
Temperatura de cor: 3200K
Fluxo luminoso: 3120lm



Pendente

Birdie

KW002W

Material: metal e silicone
Cor: branco
Tensão: bivolt
Potência: 17W +13W +9W (39W)
Soquete: LED
Medida: Ø80cmx42cm
Temperatura de cor: 3200K
Fluxo luminoso: 3120lm



Pendente

Birdie

KW002G

Material: metal e silicone
Cor: dourado e branco
Tensão: bivolt
Potência: 17W +13W +9W (39W)
Soquete: LED
Medida: Ø80cmx42cm
Temperatura de cor: 3200K
Fluxo luminoso: 3120lm





Loop



Plafon
Loop
HM007WB

Material: metal
Cor: preto e branco
Tensão: Bivolt
Potência: 40W
Soquete: LED
Medida: 47cm x 32cm x 9cm
Temperatura de cor: 3000K
Fluxo luminoso: 1100lm

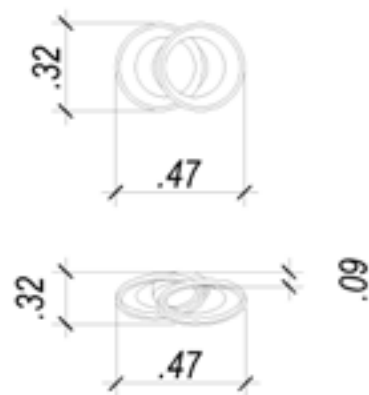

Arandela / Plafon

Loop
HM006WB

Material: metal
Cor: preto e branco
Tensão: Bivolt
Potência: 1X10W (10W)
Soquete: LED
Medida: ø22cm x 5,2cm
Temperatura de cor: 3000K
Fluxo luminoso: 330lm

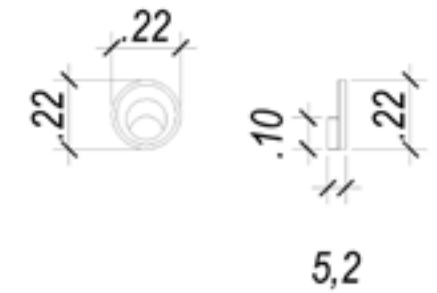

Arandela / Plafon

Loop
HM006CR

Material: metal
Cor: cromado e branco
Tensão: Bivolt
Potência: 1X10W (10W)
Soquete: LED
Medida: ø22cm x 5,2cm
Temperatura de cor: 3000K
Fluxo luminoso: 330lm

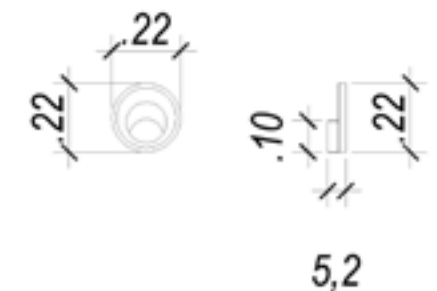

Plafon
Loop
HM008WB

Material: metal
Cor: preto e branco
Tensão: Bivolt
Potência: 1X60W (48W)
Soquete: LED
Medida: ø62cm + ø42cm
Temperatura de cor: 3000K
Fluxo luminoso: 1500lm

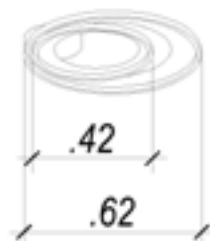

Pendente
Loop
HM009WB

Material: metal
Cor: preto e branco
Tensão: Bivolt
Potência: 1X48W (48W)
Soquete: LED
Medida: ø62cm + ø42cm x 2,2cm
Temperatura de cor: 3000K
Fluxo luminoso: 1500lm



Plafon
Loop
HM008CR

Material: metal
Cor: cromado e branco
Tensão: Bivolt
Potência: 1X60W (48W)
Soquete: LED
Medida: ø62cm + ø42cm
Temperatura de cor: 3000K
Fluxo luminoso: 1500lm

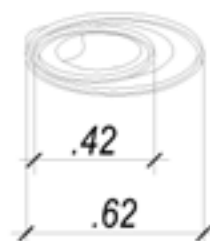

Pendente
Loop
HM009CR

Material: metal
Cor: cromado e branco
Tensão: Bivolt
Potência: 1X48W (48W)
Soquete: LED
Medida: ø62cm + ø42cm x 2,2cm
Temperatura de cor: 3000K
Fluxo luminoso: 1500lm





Pendente
Loop

HMO10WB

Material: metal
Cor: preto e branco
Tensão: Bivolt
Potência: 1X76W (76W)
Soquete: LED
Medida: ø82 cm+ ø62cm x 2,2cm
Temperatura de cor: 3000K
Fluxo luminoso: 3000lm



Pendente
Loop

HMO10CR

Material: metal
Cor: cromado e branco
Tensão: Bivolt
Potência: 1X76W (76W)
Soquete: LED
Medida: ø82 cm+ ø62cm x 2,2cm
Temperatura de cor: 3000K
Fluxo luminoso: 3000lm



Bambolê

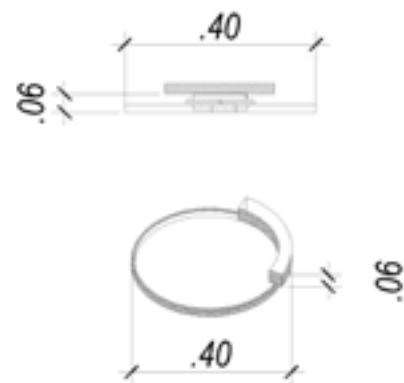

Plafon
Bambolê
FO026SB

Material: metal e silicone
Cor: preto
Tensão: Bivolt
Potência: 1X24W (24W)
Soquete: LED
Medida: ø40cm x 6cm
Temperatura de cor: 3000K
Fluxo luminoso: 813lm

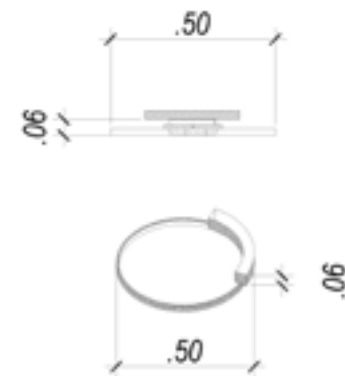

Plafon
Bambolê
FO026LB

Material: metal e silicone
Cor: preto
Tensão: Bivolt
Potência: 1X30W (30W)
Soquete: LED
Medida: ø50cm x 6cm
Temperatura de cor: 3000K
Fluxo luminoso: 1024lm

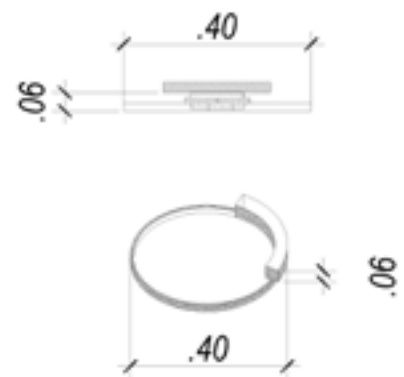

Plafon
Bambolê
FO026SW

Material: metal e silicone
Cor: branco
Tensão: Bivolt
Potência: 1X24W (24W)
Soquete: LED
Medida: ø40cm x 6cm
Temperatura de cor: 3000K
Fluxo luminoso: 1343lm

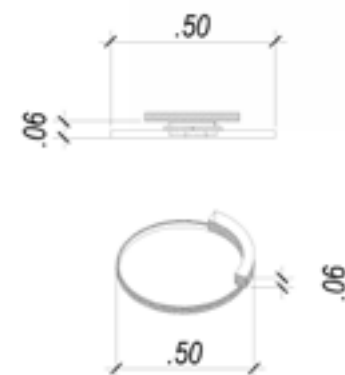

Plafon
Bambolê
FO026LW

Material: metal e silicone
Cor: branco
Tensão: Bivolt
Potência: 1X30W (30W)
Soquete: LED
Medida: ø50cm x 6cm
Temperatura de cor: 3000K
Fluxo luminoso: 2035lm



Órbita



Plafon
Órbita
GD007SW

Material: alumínio e silicone
Cor: branco
Tensão: Bivolt
Potência: 1X35W (35W)
Soquete: LED
Medida: ø54cm e ø30cm
Temperatura de cor: 3000K
Fluxo luminoso: 2060lm



Plafon
Órbita
GD007LW

Material: alumínio e silicone
Cor: branco
Tensão: Bivolt
Potência: 1X60W (60W)
Soquete: LED
Medida: ø69cm e ø38cm x 2cm
Temperatura de cor: 3000K
Fluxo luminoso: 3230lm



Plafon
Órbita
GD007SB

Material: alumínio e silicone
Cor: preto
Tensão: Bivolt
Potência: 1X35W (35W)
Soquete: LED
Medida: ø54cm e ø30cm
Temperatura de cor: 3000K
Fluxo luminoso: 2060lm



Plafon
Órbita
GD007LB

Material: alumínio e silicone
Cor: preto
Tensão: Bivolt
Potência: 1X60W (60W)
Soquete: LED
Medida: ø69cm e ø38cm x 2cm
Temperatura de cor: 3000K
Fluxo luminoso: 3230lm

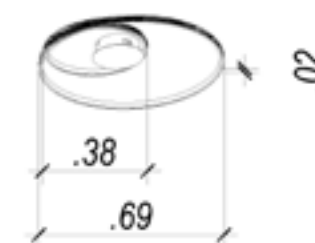
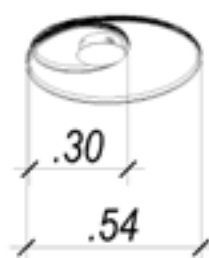



Tee

Arandela / Plafon

Tee

GDO10G

Material: alumínio e silicone
Cor: dourado
Tensão: Bivolt
Potência: 1X45W (45W)
Soquete: LED
Medida: 41cm x 41cm x 4cm
Temperatura de cor: 3000K
Fluxo luminoso: 2450lm

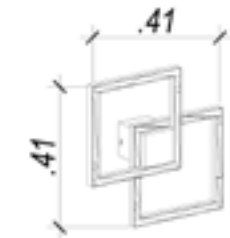

Arandela / Plafon

Tee

GDO10W

Material: alumínio e silicone
Cor: branco
Tensão: Bivolt
Potência: 1X45W (45W)
Soquete: LED
Medida: 41cm x 41cm x 4cm
Temperatura de cor: 3000K
Fluxo luminoso: 2450lm

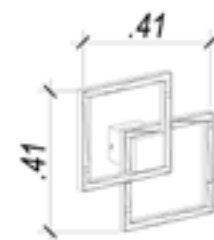

Arandela / Plafon

Tee

GDO10B

Material: alumínio e silicone
Cor: preto
Tensão: Bivolt
Potência: 1X45W (45W)
Soquete: LED
Medida: 41cm x 41cm x 4cm
Temperatura de cor: 3000K
Fluxo luminoso: 2450lm

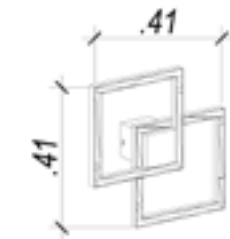

Arandela / Plafon

Tee

GD011LW

Material: alumínio e silicone
Cor: branco
Tensão: Bivolt
Potência: 1X15W (15W)
Soquete: LED
Medida: 90cm x 2cm
Temperatura de cor: 3000K
Fluxo luminoso: 980lm

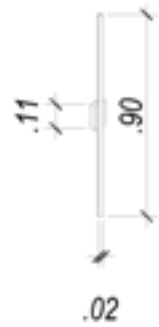

Arandela / Plafon

Tee

GD011SW

Material: alumínio e silicone
Cor: branco
Tensão: Bivolt
Potência: 1X10W (10W)
Soquete: LED
Medida: 60cm x 2cm
Temperatura de cor: 3000K
Fluxo luminoso: 620lm



Arandela / Plafon

Tee

GD011LB

Material: alumínio e silicone
Cor: preto
Tensão: Bivolt
Potência: 1X15W (15W)
Soquete: LED
Medida: 90cm x 2cm
Temperatura de cor: 3000K
Fluxo luminoso: 980lm

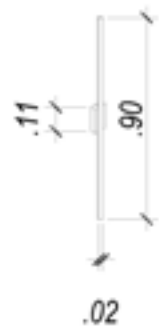

Arandela / Plafon

Tee

GD011SB

Material: alumínio e silicone
Cor: preto
Tensão: Bivolt
Potência: 1X10W (10W)
Soquete: LED
Medida: 60cm x 2cm
Temperatura de cor: 3000K
Fluxo luminoso: 620lm



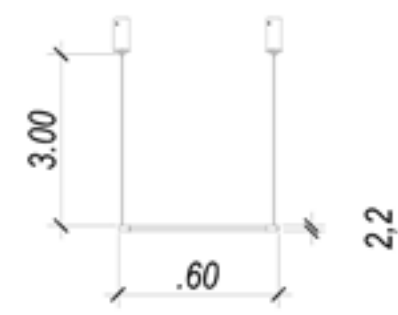

Pendente
Tee
GDO12SW

Material: alumínio e silicone
Cor: branco
Tensão: Bivolt
Potência: 1X12W (12W)
Soquete: LED
Medida: 60cm x 2,2cm
Temperatura de cor: 3000K
Fluxo luminoso: 760lm

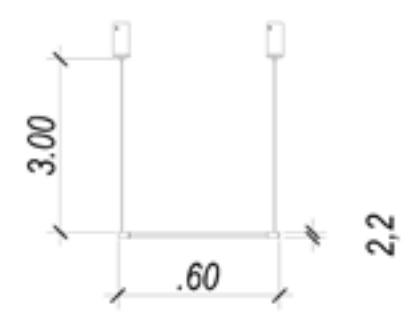

Pendente
Tee
GDO12SB

Material: alumínio e silicone
Cor: preto
Tensão: Bivolt
Potência: 1X12W (12W)
Soquete: LED
Medida: 60cm x 2,2cm
Temperatura de cor: 3000K
Fluxo luminoso: 760lm



Pendente
Tee
GDO12LB
Material: alumínio e silicone
Cor: preto
Tensão: Bivolt
Potência: 1X24W (24W)
Soquete: LED
Medida: 120 mx 2,2cm
Temperatura de cor: 3000K
Fluxo luminoso: 1410lm

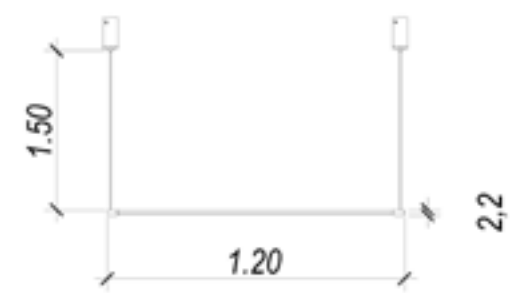

Arandela / Plafon
Tee
GDO13B
Material: alumínio e silicone
Cor: preto
Tensão: Bivolt
Potência: 1X20W (20W)
Soquete: LED
Medida: 78cm x 18cm x 6cm
Temperatura de cor: 3000K
Fluxo luminoso: 1350lm

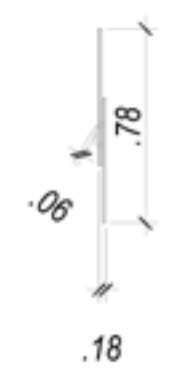

Pendente
Tee
GDO12LW
Material: alumínio e silicone
Cor: branco
Tensão: Bivolt
Potência: 1X24W (24W)
Soquete: LED
Medida: 120 mx 2,2cm
Temperatura de cor: 3000K
Fluxo luminoso: 1410lm

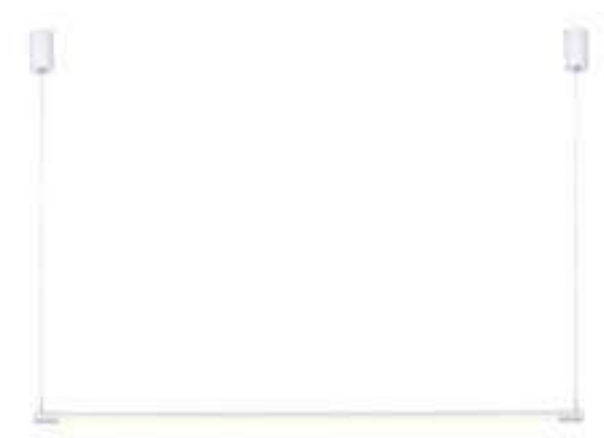

Arandela / Plafon
Tee
GDO13W
Material: alumínio e silicone
Cor: branco
Tensão: Bivolt
Potência: 1X20W (20W)
Soquete: LED
Medida: 78cm x 18cm x 6cm
Temperatura de cor: 3000K
Fluxo luminoso: 1350lm

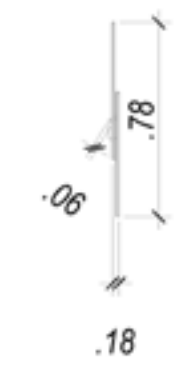

Plafon
Tee
GD014B

Material: alumínio e silicone
Cor: preto
Tensão: Bivolt
Potência: 1X30W (30W)
Soquete: LED
Medida: 40cm x 40cm x 4cm
Temperatura de cor: 3000K
Fluxo luminoso: 1790lm

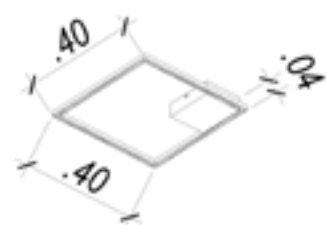

Plafon
Tee
GD014W

Material: alumínio e silicone
Cor: branco
Tensão: Bivolt
Potência: 1X30W (30W)
Soquete: LED
Medida: 40cm x 40cm x 4cm
Temperatura de cor: 3000K
Fluxo luminoso: 1790lm

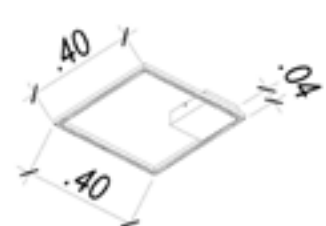



Pendente
Tee
GD015B

Material: alumínio e silicone
Cor: preto
Tensão: Bivolt
Potência: 1X32W (32W)
Soquete: LED
Medida: 30cm x 60cm x 2cm
Temperatura de cor: 3000K
Fluxo luminoso: 1810lm
Cabo: 3m

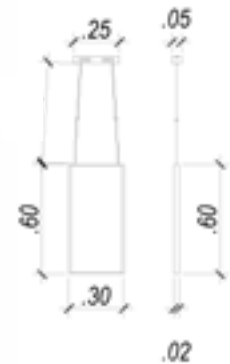

Pendente
Tee
GD016B

Material: alumínio e silicone
Cor: preto
Tensão: Bivolt
Potência: 1X32W (32W)
Soquete: LED
Medida: 60cm x 30cm x 2cm
Temperatura de cor: 3000K
Fluxo luminoso: 1810lm

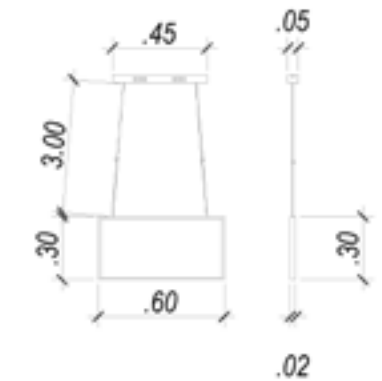
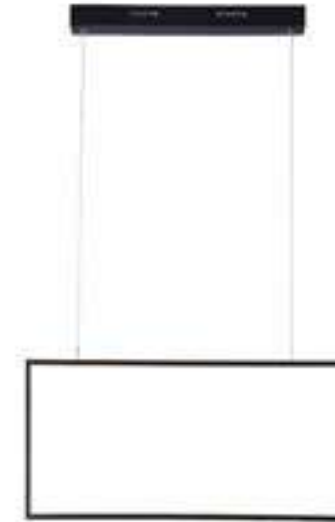

Pendente
Tee
GD015W

Material: alumínio e silicone
Cor: branco
Tensão: Bivolt
Potência: 1X32W (32W)
Soquete: LED
Medida: 30cm x 60cm x 2cm
Temperatura de cor: 3000K
Fluxo luminoso: 1810lm
Cabo: 3m

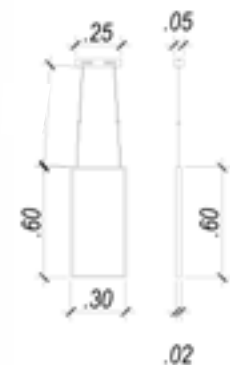

Pendente
Tee
GD016W

Material: alumínio e silicone
Cor: branco
Tensão: Bivolt
Potência: 1X32W (32W)
Soquete: LED
Medida: 60cm x 30cm x 2cm
Temperatura de cor: 3000K
Fluxo luminoso: 1810lm

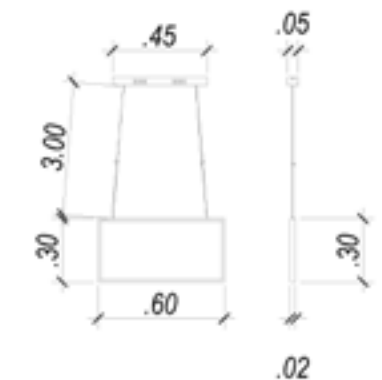



Jca

lançamentos



Pendente
Jca
GDO02NK

Material: metal e acrílico
Cor: nickel e transparente
Tensão: Bivolt
Potência: 32W + 22W (54W)
Soquete: LED
Medida: ø40cm e ø60cm x 4cm
Temperatura de cor: 3000K
Fluxo luminoso: 2970lm

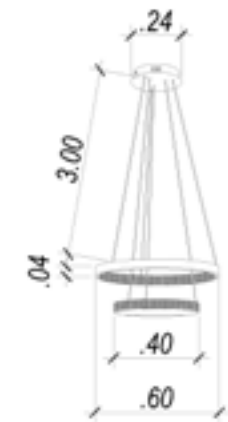

lançamentos



Pendente
Jca
GDO01NK

Material: metal e acrílico
Cor: nickel e transparente
Tensão: Bivolt
Potência: 1X32W (32W)
Soquete: LED
Medida: ø60cm x 4cm
Temperatura de cor: 3000K
Fluxo luminoso: 2080lm

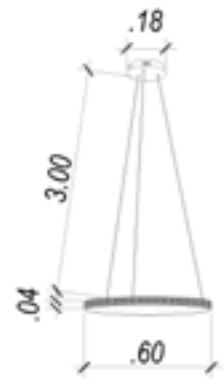

lançamentos



Pendente
Jca
GDO03NK

Material: metal e acrílico
Cor: nickel e transparente
Tensão: Bivolt
Potência: 42W + 32W (74W)
Soquete: LED
Medida: ø80cm e ø60cm x 4cm
Temperatura de cor: 3000K
Fluxo luminoso: 3700lm

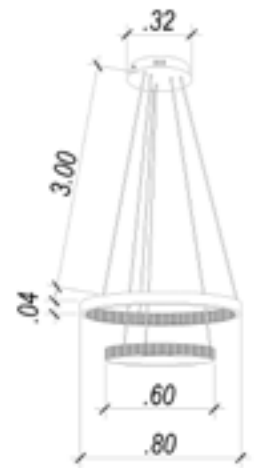



Pendente
Oca
GD001

Material: metal
Cor: dourado e transp
Tensão: bivolt
Potência: 1X32W
Soquete: LED
Medida: Ø60cmx4cm
Temperatura de cor: 3000K
Fluxo luminoso: 1881lm



Pendente
Oca
GD003

Material: metal
Cor: dourado e transp
Tensão: bivolt
Potência: 42W + 32W (74W)
Soquete: LED
Medida: Ø80+60cmx4cm
Temperatura de cor: 3000K
Fluxo luminoso: 4356lm

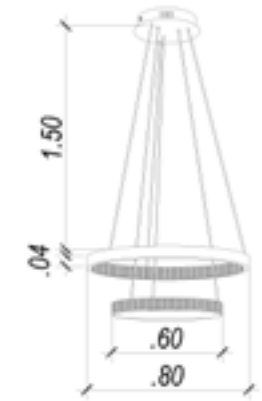

Pendente
Oca
GD002

Material: metal
Cor: dourado e transp
Tensão: bivolt
Potência: 32W + 22W (54W)
Soquete: LED
Medida: Ø60+Ø40cmx4cm
Temperatura de cor: 3000K
Fluxo luminoso: 3168lm

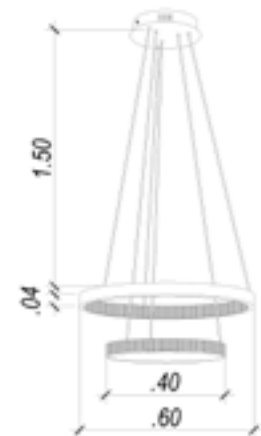

Hex



Pendente

Hex

GD005

Material: metal e acrílico
Cor: dourado e transparente
Tensão: Bivolt
Potência: 30W + 20W (50W)
Soquete: LED
Medida: ø60cm e ø40cm x 3,5cm
Temperatura de cor: 3000K
Fluxo luminoso: 2550lm

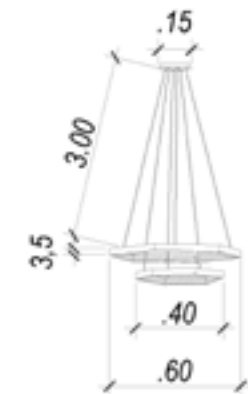

Pendente

Hex

GD004

Material: metal e acrílico
Cor: dourado e transparente
Tensão: Bivolt
Potência: 1X30W (30W)
Soquete: LED
Medida: ø60cm x 3,5cm
Temperatura de cor: 3000K
Fluxo luminoso: 1780lm



Pendente

Hex

GD006

Material: metal e acrílico
Cor: dourado e transparente
Tensão: Bivolt
Potência: 40W + 30W (70W)
Soquete: LED
Medida: ø80cm e ø60cm x 3,5cm
Temperatura de cor: 3000K
Fluxo luminoso: 3280lm

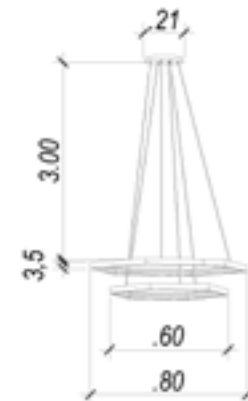



Fato

Pendente

Fato

GD008

Material: alumínio e silicone
Cor: dourado
Tensão: Bivolt
Potência: 4X15W (60W)
Soquete: LED
Medida: 120cm x 120cm x 4cm
Temperatura de cor: 3000K
Fluxo luminoso: 3210lm
Cabo: 3m

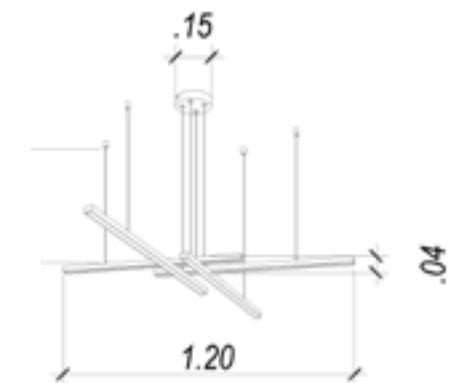

Pendente

Fato

GD009

Material: alumínio e silicone
Cor: branco
Tensão: Bivolt
Potência: 4X15W (60W)
Soquete: LED
Medida: 120cm x 120cm x 4cm
Temperatura de cor: 3000K
Fluxo luminoso: 3210lm
Cabo: 3m

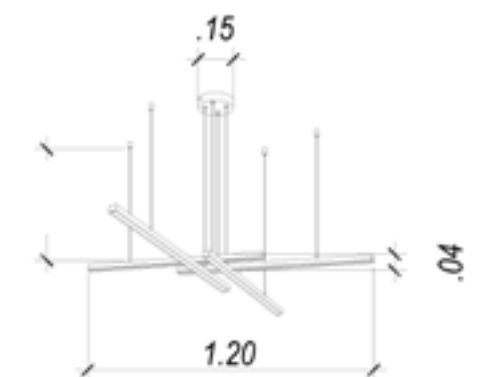



Fog

Pendente

Fog

HC018

Material: metal e vidro
Cor: rose gold preto e fume
Tensão: Bivolt
Potência: 1X10W (10W)
Soquete: LED
Medida: ø22cm x 21,5cm
Temperatura de cor: 3000K
Fluxo luminoso: 524lm



Pendente

Fog

HC017

Material: metal e vidro
Cor: rose gold preto e fume
Tensão: Bivolt
Potência: 1X10W (10W)
Soquete: LED
Medida: ø18cm x 25,5cm
Temperatura de cor: 3000K
Fluxo luminoso: 524lm

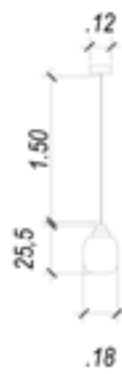

Arandela

Fog

HC019

Material: metal e vidro
Cor: rose gold preto e fume
Tensão: Bivolt
Potência: 1X10W (10W)
Soquete: LED
Medida: ø22cm x 29,5cm x 29cm
Temperatura de cor: 3000K
Fluxo luminoso: 524lm





Halo

Laçamentos



Pendente
Halo
JO005NK
Material: metal e vidro
Cor: nickel e cromado
Tensão: Bivolt
Potência: 25X28W (700W)
Soquete: G9
Medida: ø69,5cm x 24cm

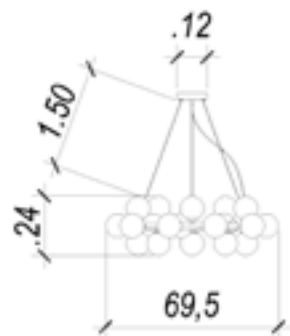

Laçamentos



Pendente
Halo
JO004NK
Material: metal e vidro
Cor: nickel e cromado
Tensão: Bivolt
Potência: 15X28W (420W)
Soquete: G9
Medida: ø56cm x 24cm

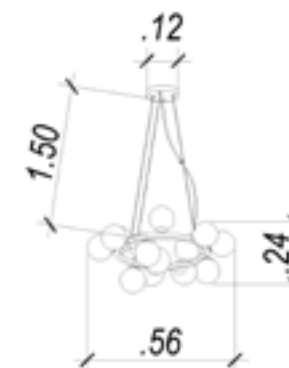

PENDENTE

Halo

JO005

Material: metal e vidro
Cor: french gold e conhaque
Tensão: bivolt
Potência: 25X20W
Soquete: G9
Medida: Ø69.5cmx24cm



Candy

Pendente

Candy

OC017

Material: metal e vidro
Cor: dourado e branco
Tensão: Bivolt
Potência: 3X10W (30W)
Soquete: LED
Medida: ø20cm x 12cm x 110cm
Temperatura de cor: 2700K
Fluxo luminoso: 2250lm

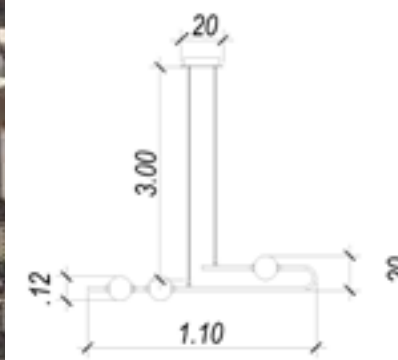

PENDENTE

Halo

JO004

Material: metal e vidro
Cor: french gold e conhaque
Tensão: bivolt
Potência: 15X20W
Soquete: G9
Medida: Ø56cmx24cm

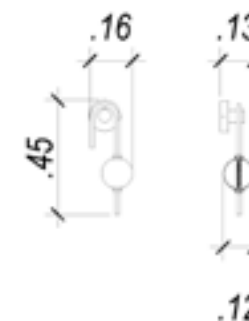

Arandela

Candy

OC018

Material: metal e vidro
Cor: dourado e branco
Tensão: Bivolt
Potência: 1X10W (10W)
Soquete: LED
Medida: 16cm x 45cm x 13cm
Temperatura de cor: 2700K
Fluxo luminoso: 750lm



Fuxico

lançamentos



Pendente
Fuxico
JU006

Material: metal e vidro
Cor: preto e dourado e branco
Tensão: Bivolt
Potência: 10X2W (20W)
Soquete: LED
Medida: ø69cm x 16cm
Temperatura de cor: 3000K
Fluxo luminoso: 1000lm

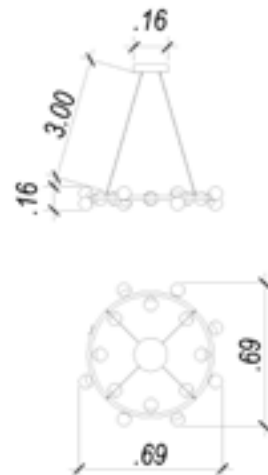

lançamentos



Pendente
Fuxico
JU007

Material: metal e vidro
Cor: preto e dourado e branco
Tensão: Bivolt
Potência: 15X2W (30W)
Soquete: LED
Medida: 95cm x 17cm
Temperatura de cor: 3000K
Fluxo luminoso: 1500lm

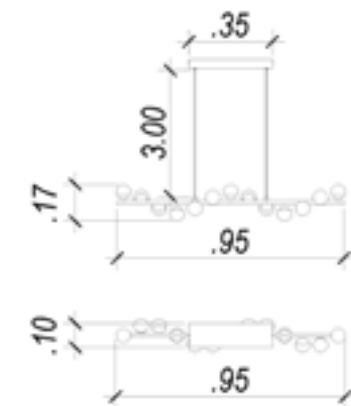

lançamentos



Arandela
Fuxico
JU008

Material: metal e vidro
Cor: preto e dourado e branco
Tensão: Bivolt
Potência: 3X2W (6W)
Soquete: LED
Medida: 18,2cm x 26cm
Temperatura de cor: 3000K
Fluxo luminoso: 300lm

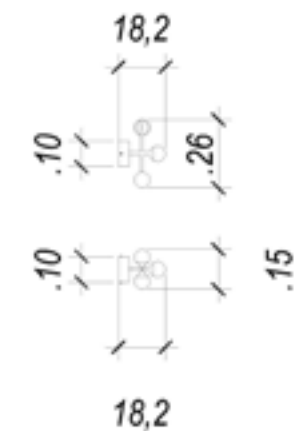



Pendente
Fuxico
JU001

Material: aço alumínio e acrílico
Cor: dourado e preto e branco
Tensão: bivolt
Potência: 4X3W (12W)
Soquete: LED
Medida: Ø32cmx45cm
Temperatura de cor: 3000K
Fluxo luminoso: 600lm



Pendente
Fuxico
JU002

Material: aço alumínio e acrílico
Cor: dourado e preto e branco
Tensão: bivolt
Potência: 12X3W(36W)
Soquete: LED
Medida: 32cmx100cmx45cm
Temperatura de cor: 3000K
Fluxo luminoso: 1800lm

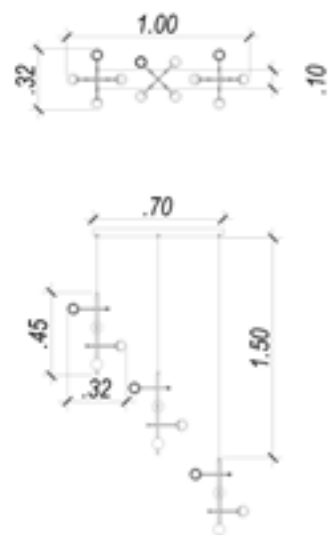

Plafon
Fuxico
JU005

Material: aço alumínio e acrílico
Cor: dourado e preto e branco
Tensão: bivolt
Potência: 15X3W (45W)
Soquete: LED
Medida: Ø58cmx30cm
Temperatura de cor: 3000K
Fluxo luminoso: 2250lm



Coluna
Fuxico
JU003

Material: aço alumínio e acrílico
Cor: dourado e preto e branco
Tensão: bivolt
Potência: 8X3W(24W)
Soquete: LED
Medida: Ø30cmx60cm
Temperatura de cor: 3000K
Fluxo luminoso: 1200lm



Abajur
Fuxico
JU004

Material: aço alumínio e acrílico
Cor: dourado e preto e branco
Tensão: bivolt
Potência: 4X3W (12W)
Soquete: LED
Medida: Ø28cmx52cm
Temperatura de cor: 3000K
Fluxo luminoso: 600lm

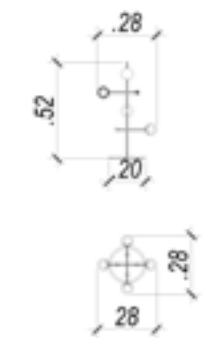

Mantra

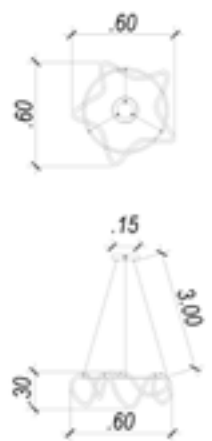

Pendente
Mantra
OC011S

Material: metal e silicone
Cor: dourado e branco
Tensão: Bivolt
Potência: 1X35W (35W)
Soquete: LED
Medida: ø60cm x 30cm
Temperatura de cor: 2700K
Fluxo luminoso: 2625lm



Pendente
Mantra
OC011L

Material: metal e silicone
Cor: dourado e branco
Tensão: Bivolt
Potência: 1X45W (45W)
Soquete: LED
Medida: ø80cm x 30cm
Temperatura de cor: 2700K
Fluxo luminoso: 3375lm

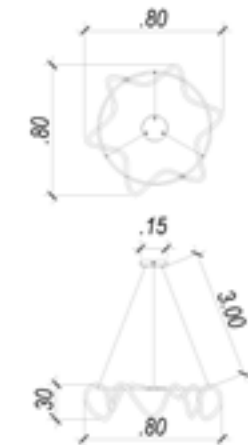

Pendente
Mantra
OC012

Material: metal e silicone
Cor: dourado e branco
Tensão: Bivolt
Potência: 1X40W (40W)
Soquete: LED
Medida: 120cm x 30cm
Temperatura de cor: 2700K
Fluxo luminoso: 3000lm

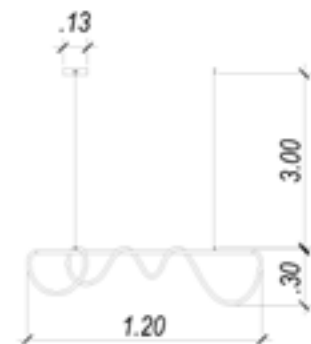



Pendente
Mantra
OC010

Material: metal e silicone
Cor: dourado e branco
Tensão: Bivolt
Potência: 1X12W (12W)
Soquete: LED
Medida: 20cm x 120cm
Temperatura de cor: 2700K
Fluxo luminoso: 900lm



Arandela
Mantra
OC013

Material: metal e silicone
Cor: dourado e branco
Tensão: Bivolt
Potência: 1X8W (8W)
Soquete: LED
Medida: ø15cm x 40cm
Temperatura de cor: 2700K
Fluxo luminoso: 600lm

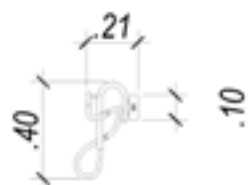

Calix

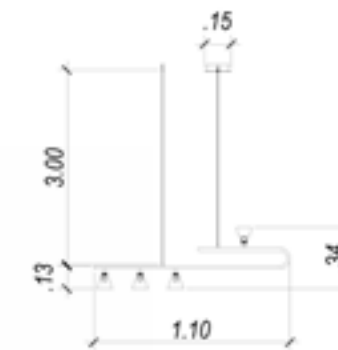
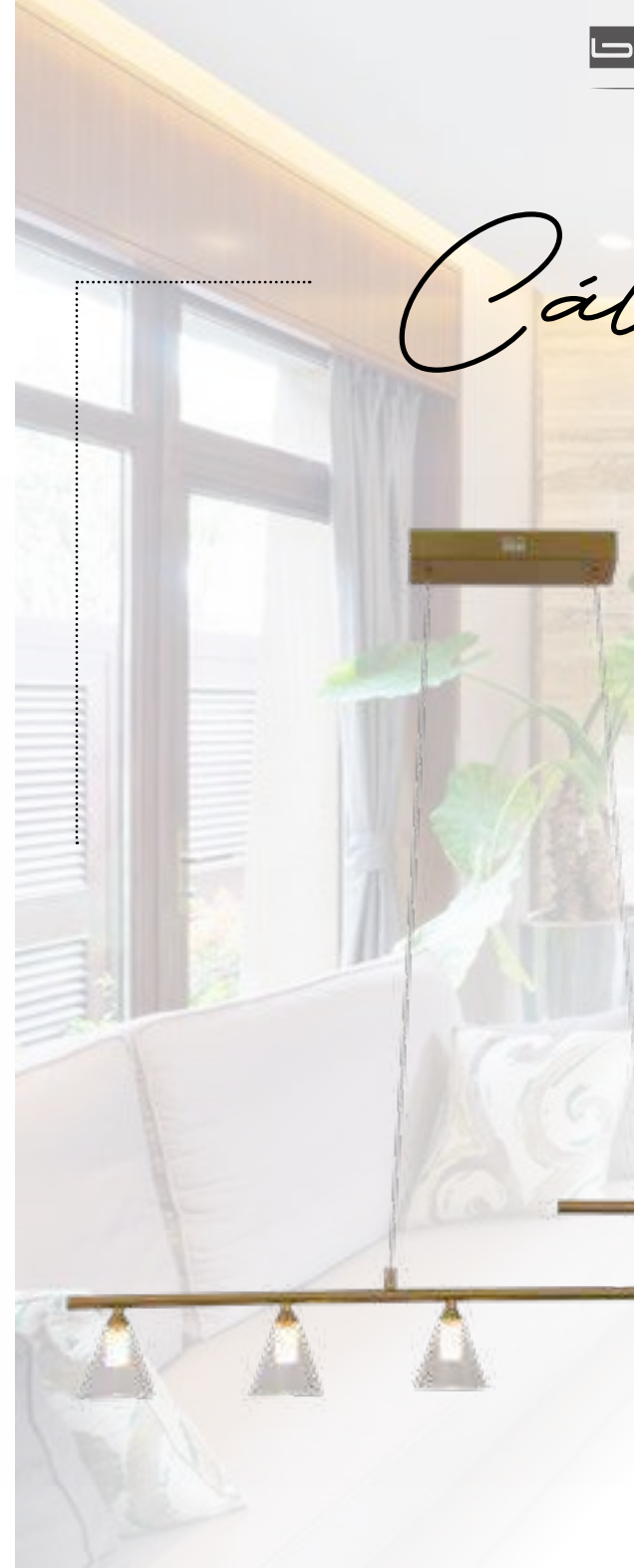

Pendente
Calix
OC019

Material: metal e vidro
Cor: dourado e transparente
Tensão: Bivolt
Potência: 4X3W (12W)
Soquete: LED
Medida: 9c, x 110cm x 34cm
Temperatura de cor: 2700K
Fluxo luminoso: 900lm

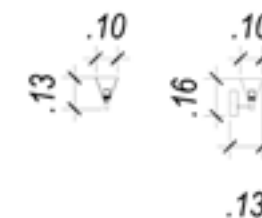

Arandela
Calix
OC020

Material: metal e vidro
Cor: dourado e transparente
Tensão: Bivolt
Potência: 1X3W (3W)
Soquete: LED
Medida: 16cmx 10cm x 13cm
Temperatura de cor: 2700K
Fluxo luminoso: 225lm





Oggi

Pendente
Oggi
OC015

Material: metal e acrílico
Cor: dourado e transparente
Tensão: Bivolt
Potência: 10X3W (30W)
Soquete: LED
Medida: 15cm x 101cm x 28cm
Temperatura de cor: 2700K
Fluxo luminoso: 2250lm

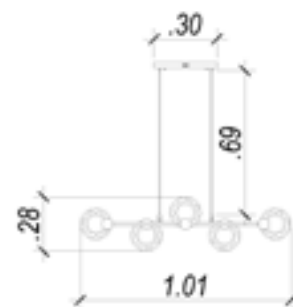

Arandela
Oggi
OC016

Material: metal e acrílico
Cor: dourado e transparente
Tensão: Bivolt
Potência: 2X3W (6W)
Soquete: LED
Medida: 7cm x 18cm x 10cm
Temperatura de cor: 2700K
Fluxo luminoso: 450lm

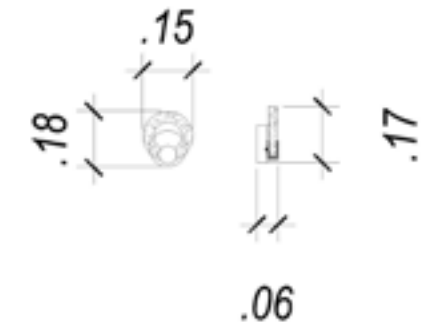

Pendente
Oggi
OC014

Material: metal e acrílico
Cor: dourado e transparente
Tensão: Bivolt
Potência: 2X3W (6W)
Soquete: LED
Medida: ø15cm
Temperatura de cor: 2700K
Fluxo luminoso: 450lm



Coralina



Pendente
Coralina
OC021

Material: metal e vidro
Cor: dourado e transparente
Tensão: Bivolt
Potência: 6X2W (12W)
Soquete: LED
Medida: ø70cm x 24cm
Temperatura de cor: 2700K
Fluxo luminoso: 900lm
Cabo: 3m

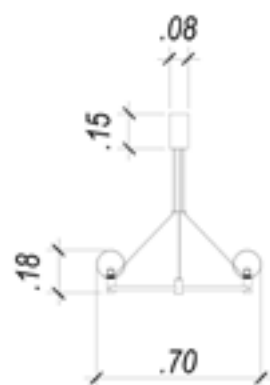

Arandela
Coralina
OC022

Material: metal e vidro
Cor: dourado e transparente
Tensão: Bivolt
Potência: 1X2W (2W)
Soquete: LED
Medida: 12cm x 37cm x 15,5cm
Temperatura de cor: 2700K
Fluxo luminoso: 150lm

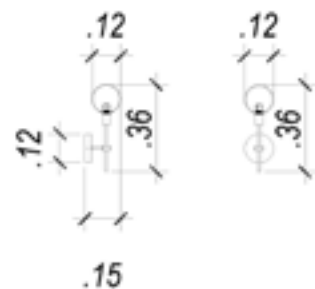

Petit Poa



lançamentos

Pendente
Petit Poa
SQ002B

Material: metal e vidro
Cor: cromo negro e branco
Tensão: Bivolt
Potência: 5X5W (25W)
Soquete: E27 BOLINHA
Medida: 98cm x 15cm x 28cm

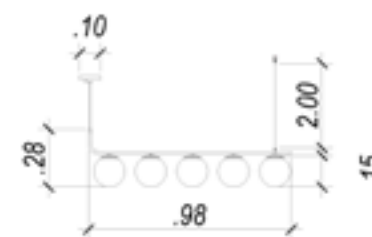

lançamentos



Pendente
Petty Poa
SQ004B
Material: metal e vidro
Cor: cromo negro e branco
Tensão: Bivolt
Potência: 6X5W (30W)
Soquete: E27 BOLINHA
Medida: ø31cm x 140cm

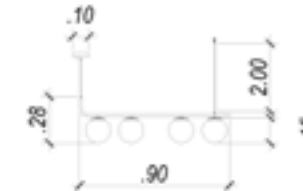
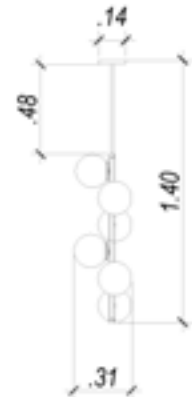

lançamentos

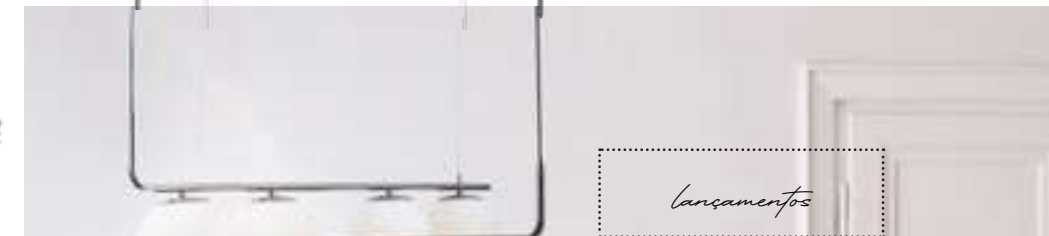

Pendente
Petty Poa
SQ003B
Material: metal e vidro
Cor: cromo negro e branco
Tensão: Bivolt
Potência: 8X5W (40W)
Soquete: E27 BOLINHA
Medida: ø90cm x 28cm



lançamentos

Arandela
Petty Poa
SQ005B
Material: metal e vidro
Cor: cromo negro e branco
Tensão: Bivolt
Potência: 1X5W (5W)
Soquete: E27 BOLINHA
Medida: 20cm x 15cm x 17cm

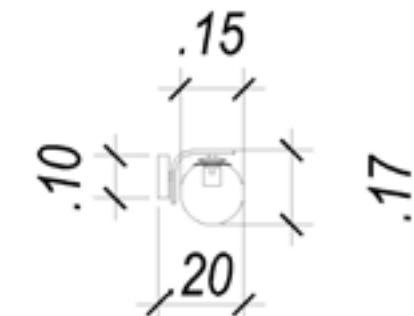

Pendente
Petty Poa
SQ001B
Material: metal e vidro
Cor: cromo negro e branco
Tensão: Bivolt
Potência: 3X5W (15W)
Soquete: E27 BOLINHA
Medida: 60cm x 15cm x 27cm

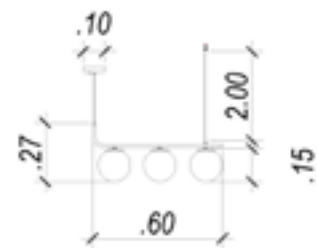

lançamentos



PENDENTE

Petty Poa

SQ002

Material: metal e vidro
Cor: french gold e branco
Tensão: bivolt
Potência: 5X5W
Soquete: E27 BOLINHA
Medida: 15cmx98cmx28cm

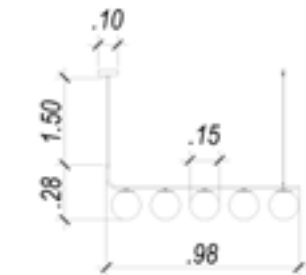

PENDENTE

Petty Poa

SQ001

Material: metal e vidro
Cor: french gold e branco
Tensão: bivolt
Potência: 3X5W
Soquete: E27 BOLINHA
Medida: 15cmx60cmx27cm

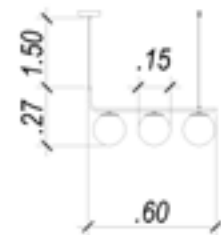

PENDENTE

Petty Poa

SQ003

Material: metal e vidro
Cor: french gold e branco
Tensão: bivolt
Potência: 8X5W
Soquete: E27 BOLINHA
Medida: Ø90cmx28cm

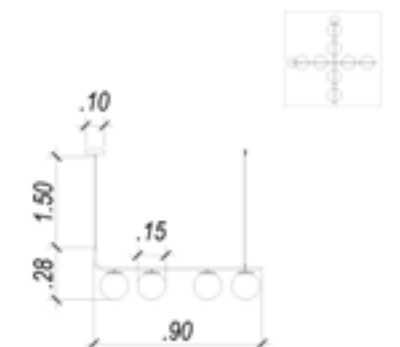

PENDENTE

Petit Poo

SQ004

Material: metal e vidro
Cor: french gold e branco
Tensão: bivolt
Potência: 6X5W
Soquete: E27 BOLINHA
Medida: Ø31cmx140cm

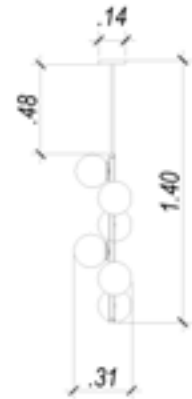

ARANDELA

Petit Poo

SQ005

Material: metal e vidro
Cor: french gold e branco
Tensão: bivolt
Potência: 1X5W
Soquete: E27 BOLINHA
Medida: 15cmx20cmx17cm

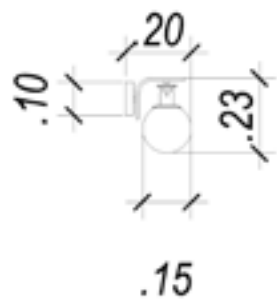

Lindo

lançamentos

Plafon

Lindo

TRO06B

Material: metal e vidro
Cor: preto e branco
Tensão: Bivolt
Potência: 3X25W (75W)
Soquete: G9
Medida: ø60cm x 32cm



PLAFON

Lindo

TRO06

Material: metal e vidro
Cor: dourado e branco
Tensão: bivolt
Potência: 3X25W(75W)
Soquete: G9
Medida: Ø60cmx32cm

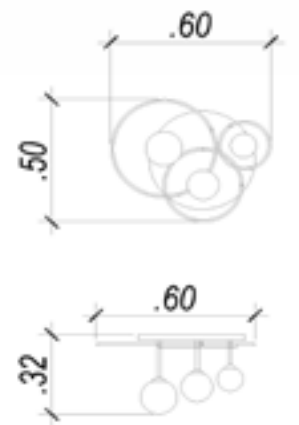

Factory

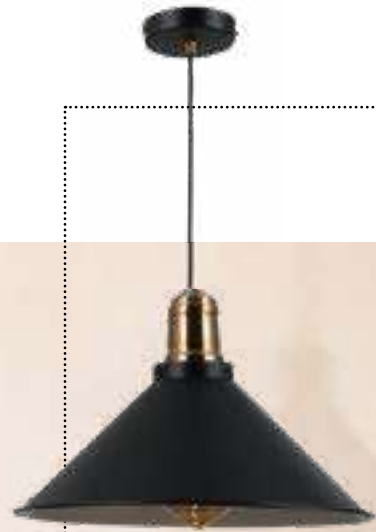

Pendente

Factory

SQ009

Material: metal
Cor: preto e dourado
Tensão: Bivolt
Potência: 1X40W (40W)
Soquete: E27
Medida: ø30cm x 22cm



Arandela

Factory

SQ010

Material: metal
Cor: preto e dourado
Tensão: Bivolt
Potência: 1X40W (40W)
Soquete: E27
Medida: 27cm x 18cm x 25cm

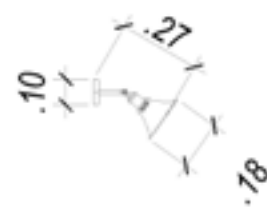

Titia

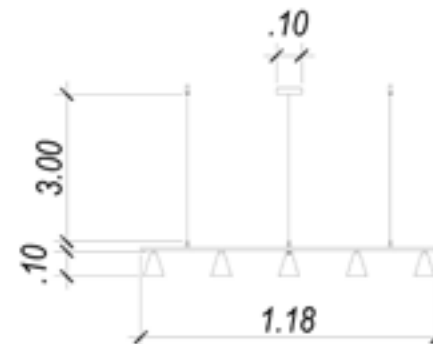

Pendente

Titia

DW002

Material: metal
Cor: dourado
Tensão: Bivolt
Potência: 5X7W (35W)
Soquete: G9
Medida: 118cm x 10cm





Viva

lançamentos

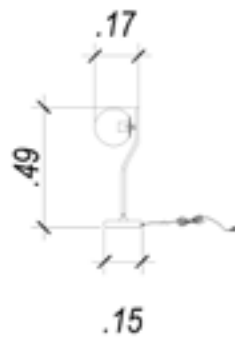

Abajur
Viva
SQ007B
Material: metal e vidro
Cor: cromo negro e branco
Tensão: Bivolt
Potência: 1X5W (5W)
Soquete: E27 BOLINHA
Medida: ø17cm x 49cm



Pendente
Viva
SQ006B
Material: metal e vidro
Cor: cromo negro e branco
Tensão: Bivolt
Potência: 1X5W (5W)
Soquete: E27 BOLINHA
Medida: ø16cm x 45cm

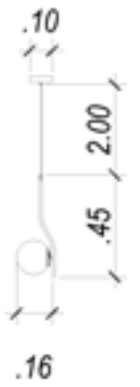

Coluna
Viva
SQ008B
Material: metal e vidro
Cor: cromo negro e branco
Tensão: Bivolt
Potência: 1X5W (5W)
Soquete: E27 BOLINHA
Medida: ø25cm x 160cm





PENDENTE

Viva

SQ006

Material: aço alumínio e vidro
Cor: french gold e branco
Tensão: bivolt
Potência: 1X5W
Soquete: E27 BOLINHA
Medida: Ø16cmx45cm



COLUNA

Viva

SQ008

Material: aço alumínio e vidro
Cor: french gold e branco
Tensão: bivolt
Potência: 1X5W
Soquete: E27 BOLINHA
Medida: Ø25cmx160cm

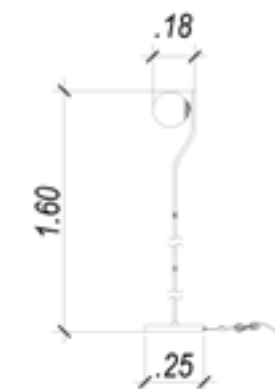

ABAJUR

Viva

SQ007

Material: aço alumínio e vidro
Cor: french gold e branco
Tensão: bivolt
Potência: 1X5W
Soquete: E27 BOLINHA
Medida: Ø17cmx49cm

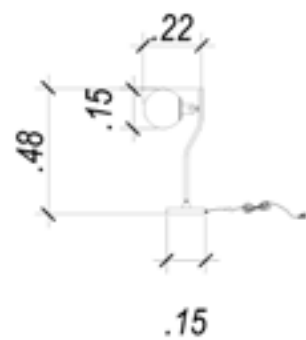

Pingo



Pendente
Pingo
TRO01B
Material: metal e vidro
Cor: preto e cromado
Tensão: Bivolt
Potência: 1X25W (25W)
Soquete: G9
Medida: ø18cm x 30cm

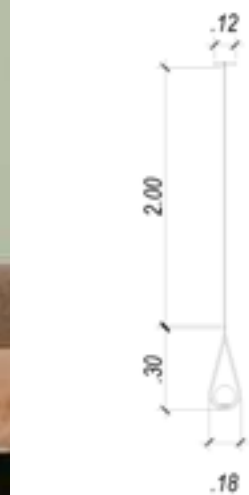

lançamentos



Arandela
Pingo
TRO02B
Material: metal e vidro
Cor: preto e cromado
Tensão: Bivolt
Potência: 1X25W (25W)
Soquete: G9
Medida: ø20cm x 47,4cm

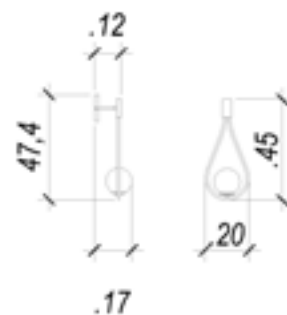

ARANDELA
Pingo
TRO02

Material: metal e vidro
Cor: bronze e branco
Tensão: bivolt
Potência: 1X25W
Soquete: G9
Medida: Ø20cmx42cm

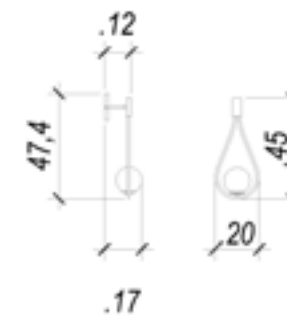

PENDENTE
Pingo
TRO01

Material: metal e vidro
Cor: bronze e branco
Tensão: bivolt
Potência: 1X25W
Soquete: G9
Medida: Ø18cmx49cm





Calder

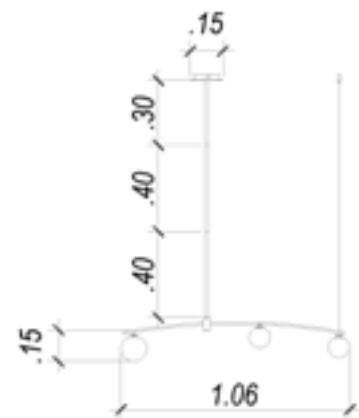

Pendente
Calder
DW003

Material: metal e vidro
Cor: dourado e branco
Tensão: Bivolt
Potência: 3X7W (21W)
Soquete: G9
Medida: 15cm x 106cm x 133cm

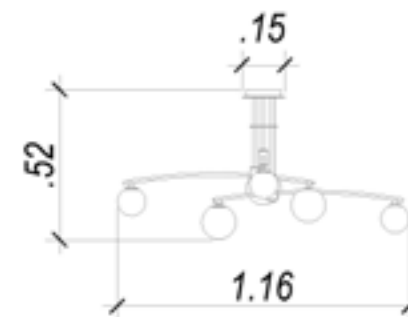
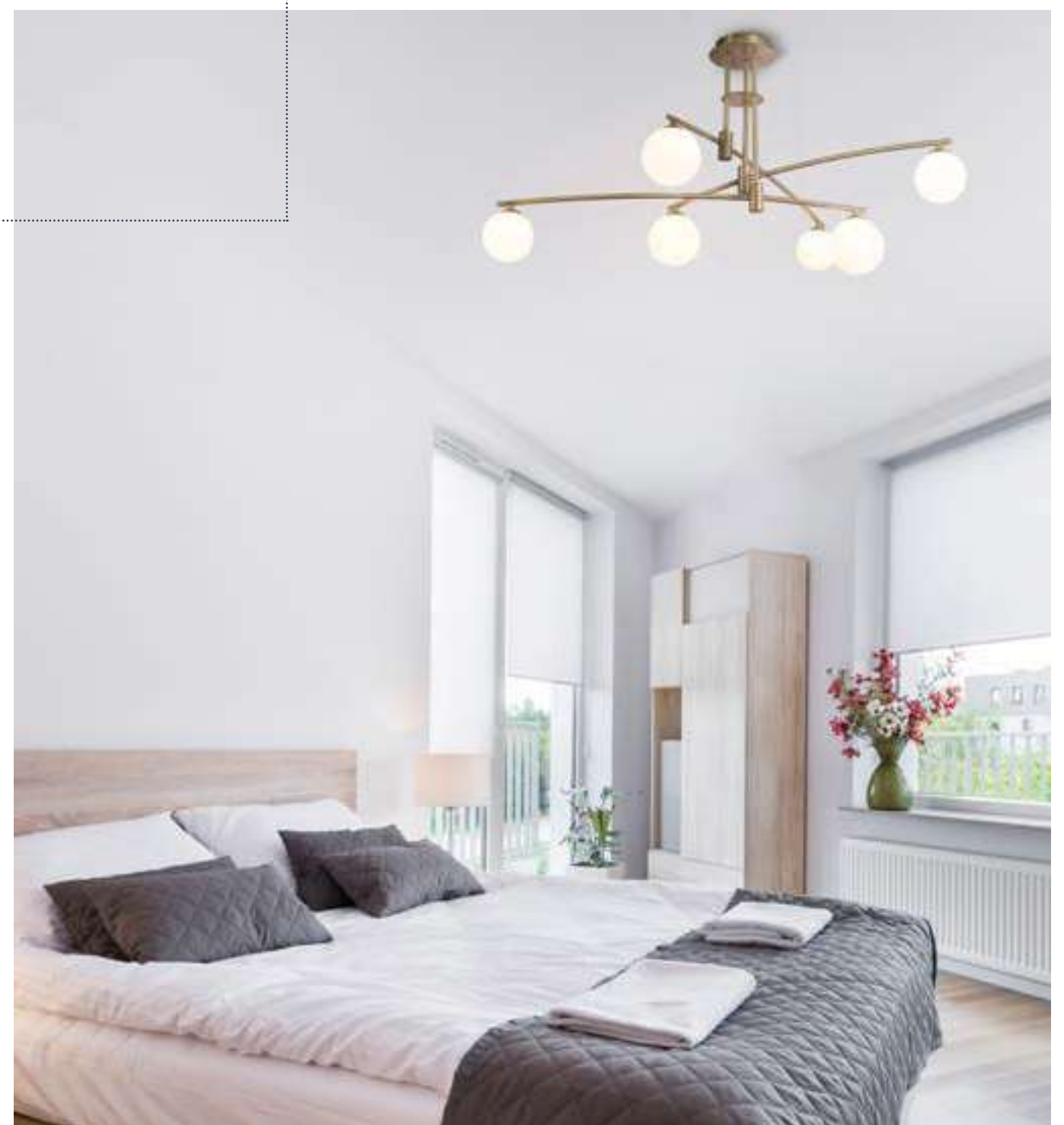

Plafon
Calder
DW004

Material: metal e vidro
Cor: dourado e branco
Tensão: Bivolt
Potência: 6X7W (42W)
Soquete: G9
Medida: 116cm x 52cm



lançamentos



Balanço



Pendente
Balanço
TRO05B
Material: metal e vidro
Cor: preto e fume
Tensão: Bivolt
Potência: 3X25W (75W)
Soquete: G9
Medida: 45cm x 35cm



lançamentos



Pendente
Balanço
TRO03B
Material: metal e vidro
Cor: preto e fume
Tensão: Bivolt
Potência: 3X25W (75W)
Soquete: G9
Medida: 60cm x 30cm

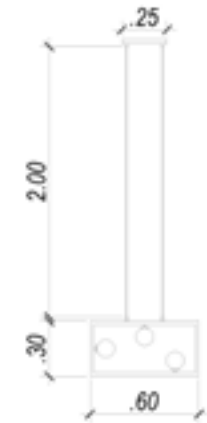

lançamentos



Pendente
Balanço
TRO04B
Material: metal e vidro
Cor: preto e fume
Tensão: Bivolt
Potência: 3X25W (75W)
Soquete: G9
Medida: 30cm x 60cm





PENDENTE

Balanço

TRO03

Material: metal e vidro
Cor: dourado e branco
Tensão: bivolt
Potência: 3X25W (75W)
Soquete: G9
Medida: Ø60cmx30cm



PENDENTE

Balanço

TRO05

Material: metal e vidro
Cor: dourado e branco
Tensão: bivolt
Potência: 3X25W (75W)
Soquete: G9
Medida: Ø45cmx35cm



PENDENTE

Balanço

TRO04

Material: metal e vidro
Cor: dourado e branco
Tensão: bivolt
Potência: 3X25W (75W)
Soquete: G9
Medida: Ø30cmx60cm

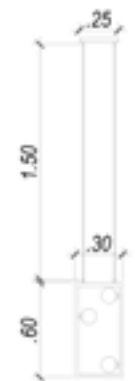

Bem-te-vi



Pendente
Bem-te-Vi
TRO07

Material: metal e vidro
Cor: preto e dourado e branco
Tensão: Bivolt
Potência: 3X25W (75W)
Soquete: G9
Medida: 156cm x 30cm



Caê

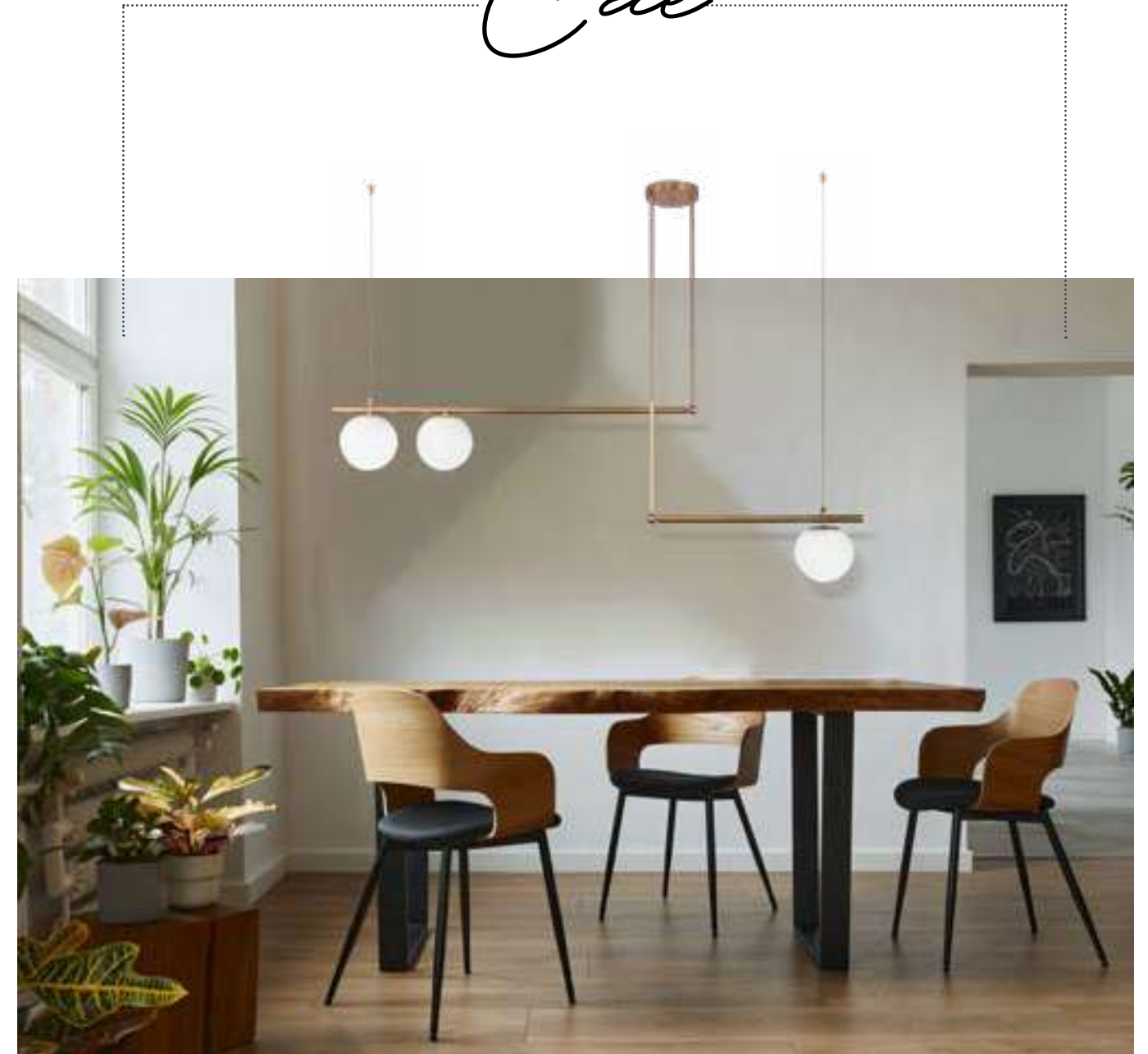

Pendente
Caê
DW007

Material: metal e vidro
Cor: dourado e branco
Tensão: Bivolt
Potência: 3X7W (21W)
Soquete: G9
Medida: 15cm x 153cm x 130cm

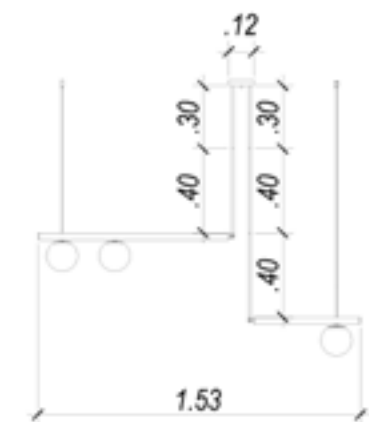

Abaporu

lançamentos

Arandela
Abaporu
HLO14B

Material: metal e vidro
Cor: preto e fume
Tensão: Bivolt
Potência: 1X25W (25W)
Soquete: G9
Medida: 16cm x 12cm x 32cm



lançamentos

Arandela
Abaporu
HLO14G

Material: metal e vidro
Cor: dourado e ambar
Tensão: Bivolt
Potência: 1X25W (25W)
Soquete: G9
Medida: 16cm x 12cm x 32cm

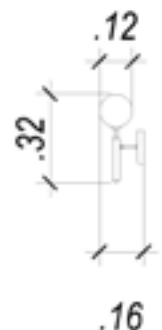

ARANDELA
Abaporu
HLO14

Material: metal e vidro
Cor: dourado e branco
Tensão: bivolt
Potência: 1X25W
Soquete: G9
Medida: 12cmx21cmx32cm



PENDENTE
Abaporu
HLO03W

Material: metal e vidro
Cor: dourado e branco
Tensão: bivolt
Potência: 6X25W
Soquete: G9
Medida: 30cmx92cmx23cm

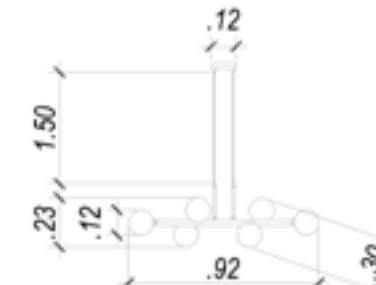

PENDENTE
Abaporu
HLO04W

Material: metal e vidro
Cor: dourado e branco
Tensão: bivolt
Potência: 8X25W
Soquete: G9
Medida: 30cmx107cmx23cm

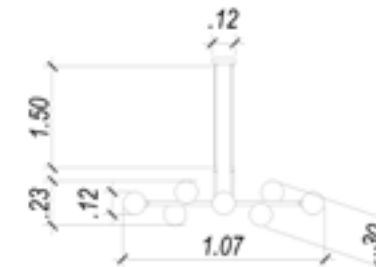

PENDENTE

Abaporu

HL004B

Material: metal e vidro
Cor: preto e fume
Tensão: bivolt
Potência: 8X25W
Soquete: G9
Medida: 110cmx34cmx28cm

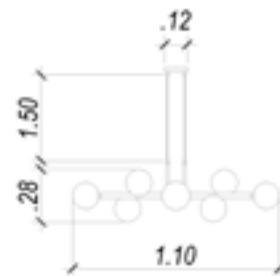

PENDENTE

Abaporu

HL003B

Material: metal e vidro
Cor: preto e fume
Tensão: bivolt
Potência: 6X25W
Soquete: G9
Medida: 95cmx31cmx28cm

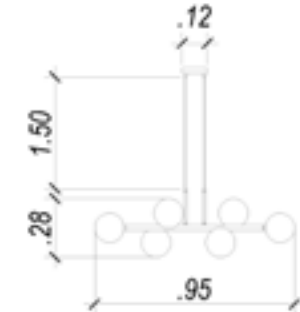

PENDENTE

Abaporu

HL004G

Material: metal e vidro
Cor: bronze e champagne
Tensão: bivolt
Potência: 8X25W
Soquete: G9
Medida: 110cmx34cmx28cm

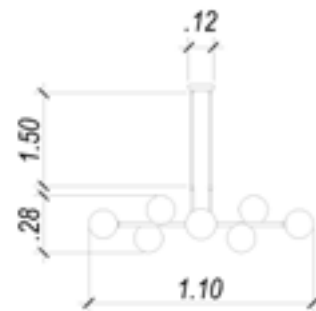

PENDENTE

Abaporu

HL003G

Material: metal e vidro
Cor: bronze e champagne
Tensão: bivolt
Potência: 6X25W
Soquete: G9
Medida: 95cmx31cmx28cm

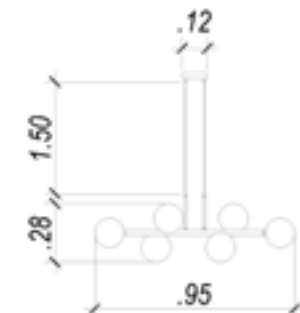

Quica

lançamentos

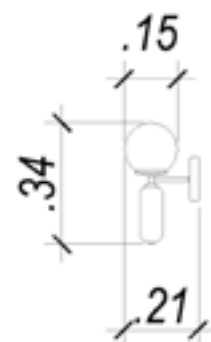

Arandela
Quica
HL016
Material: metal e vidro
Cor: bronze e branco
Tensão: Bivolt
Potência: 1X25W (25W)
Soquete: E27 BOLINHA
Medida: 21cm x 15cm x 34cm



PENDENTE

Quica
HL008M

Material: metal e vidro
Cor: bronze e branco
Tensão: bivolt
Potência: 1X40W
Soquete: E27
Medida: Ø30cmx47cm



PENDENTE

Quica
HL008S

Material: metal e vidro
Cor: bronze e branco
Tensão: bivolt
Potência: 1X40W
Soquete: E27 (bolinha)
Medida: Ø15cmx31.5cm



Bambu

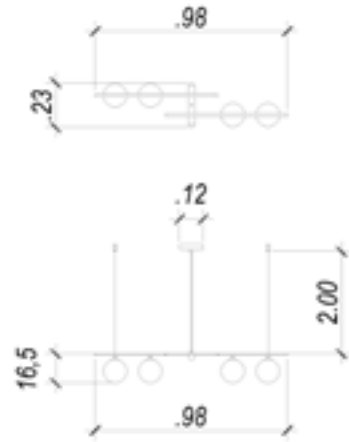

Pendente
Bambu
HL017LW
Material: metal e vidro
Cor: preto bronze e branco
Tensão: Bivolt
Potência: 4X25W (100W)
Soquete: G9
Medida: 23cm x 98cm x 16,5cm



Pendente
Bambu
HL017LB
Material: metal e vidro
Cor: preto bronze e fume
Tensão: Bivolt
Potência: 4X25W (100W)
Soquete: G9
Medida: 23cm x 98cm x 16,5cm

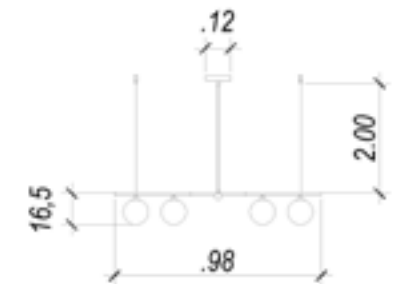

Pendente
Bambu
HLO17SW
Material: metal e vidro
Cor: preto bronze e branco
Tensão: Bivolt
Potência: 3X25W (75W)
Soquete: G9
Medida: 19cm x 80cm x 29cm

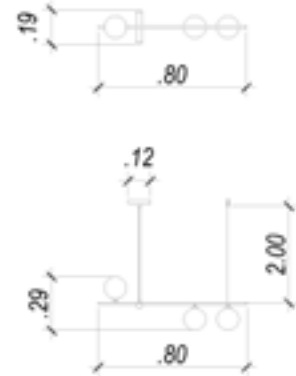

Pendente
Bambu
HLO19
Material: metal e vidro
Cor: preto bronze e fume
Tensão: Bivolt
Potência: 4X25W (100W)
Soquete: G9
Medida: 29cmx 92cm x53cm

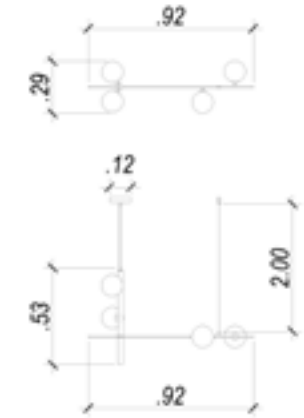

Pendente
Bambu
HLO17SB
Material: metal e vidro
Cor: preto bronze e fume
Tensão: Bivolt
Potência: 3X25W (75W)
Soquete: G9
Medida: 19cm x 80cm x 29cm

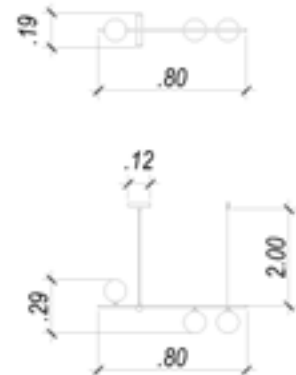

Pendente
Bambu
HLO18
Material: metal e vidro
Cor: preto bronze e fume
Tensão: Bivolt
Potência: 4X25W (100W)
Soquete: G9
Medida: 31,5cm x104cm x 22cm

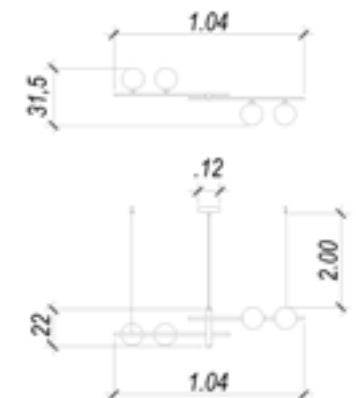

Caju



lançamentos

Abajur
Caju
RZ003G
Material: metal e vidro
Cor: bronze e conhaque
Tensão: Bivolt
Potência: 1X40W (40W)
Soquete: E27
Medida: ø30cm x 58cm



lançamentos

Coluna
Caju
RZ004G
Material: metal e vidro
Cor: bronze e conhaque
Tensão: Bivolt
Potência: 1X40W (40W)
Soquete: E27
Medida: ø40cm x 145cm

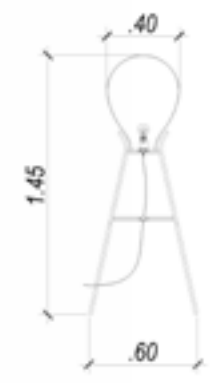

PENDENTE
Caju
RZ001ES
Material: metal e vidro
Cor: bronze e conhaque
Tensão: bivolt
Potência: 1X40W
Soquete: E14
Medida: Ø21,5cmx29,5cm



PENDENTE
Caju
RZ001S
Material: metal e vidro
Cor: bronze e conhaque
Tensão: bivolt
Potência: 1X40W
Soquete: E27
Medida: Ø30cmx40cm



PENDENTE
Caju
RZ001L
Material: metal e vidro
Cor: bronze e conhaque
Tensão: bivolt
Potência: 1X40W
Soquete: E27
Medida: Ø40cmx52cm



PENDENTE
Caju
RZ001EL
Material: metal e vidro
Cor: bronze e conhaque
Tensão: bivolt
Potência: 3X40W
Soquete: E27
Medida: Ø48cmx63cm





ABAJUR

Caju

RZ003

Material: metal e vidro
Cor: preto e cromado
Tensão: bivolt
Potência: 1X40W
Soquete: E27
Medida: Ø30cmx58cm



PENDENTE

Caju

RZ001ESB

Material: metal e vidro
Cor: preto e cromado
Tensão: bivolt
Potência: 1X40W
Soquete: E14
Medida: Ø23cmx30cm



PENDENTE

Caju

RZ001SB

Material: metal e vidro
Cor: preto e cromado
Tensão: bivolt
Potência: 1X40W
Soquete: E27
Medida: Ø30cmx40cm

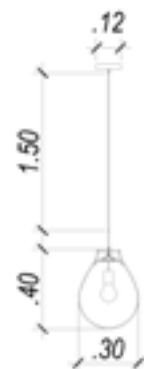

COLUNA

Caju

RZ004

Material: metal e vidro
Cor: preto e cromado
Tensão: bivolt
Potência: 1X40W
Soquete: E27
Medida: Ø40cmx154cm



Maison

lançamentos

Arandela
Maison
MO0016G

Material: metal e vidro
Cor: french gold e transparente
Tensão: Bivolt
Potência: 1X40W (40W)
Soquete: G9
Medida: 12cm x 14cm x 19,5cm

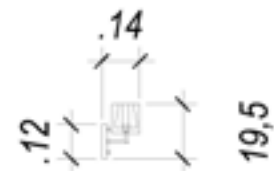

ARANDELA
Maison
MO0016E

Material: metal e vidro
Cor: cobre e transp
Tensão: bivolt
Potência: 1X40W
Soquete: G9
Medida: 12cmx14cmx19.5cm

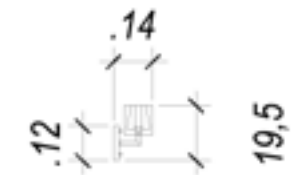

ARANDELA
Maison
MO0016

Material: metal e vidro
Cor: cromado e transp
Tensão: bivolt
Potência: 1X40W
Soquete: G9
Medida: 12cmx14cmx19.5cm



BELLA
15 años iluminando

decorativo



Link

Abajur

Link

FT003

Material: aço alumínio e acrílico
Cor: dourado preto e branco
Tensão: bivolt
Potência: 3X6W (18W)
Soquete: LED
Medida: 12cm x 27cm x 43cm
Temperatura de cor: 3000K
Fluxo luminoso: 900lm

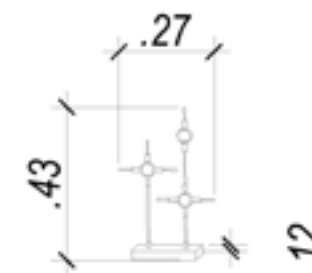

Arandela

Link

FT002

Material: aço alumínio e acrílico
Cor: dourado preto e branco
Tensão: bivolt
Potência: 4X4W (16W)
Soquete: LED
Medida: 39cm x 5cm x 60cm
Temperatura de cor: 3000K
Fluxo luminoso: 700lm

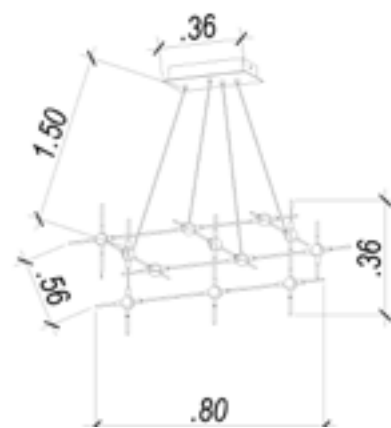
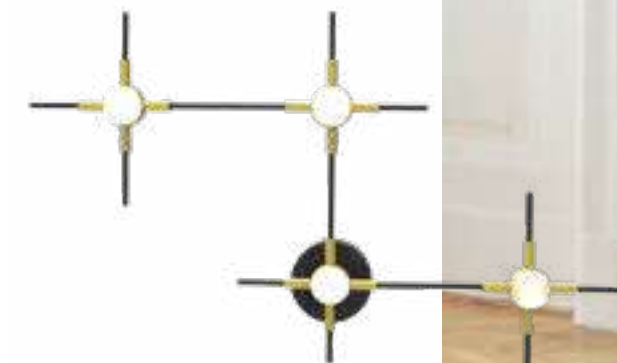
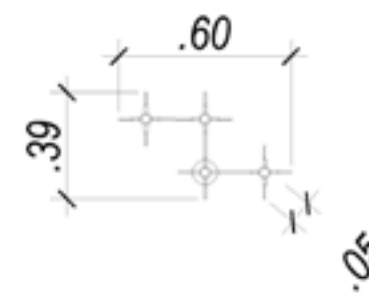

Pendente

Link

FT001

Material: aço alumínio e acrílico
Cor: dourado preto e branco
Tensão: bivolt
Potência: 12X4W (48W)
Soquete: LED
Medida: 56cm x 80cm x 36cm
Temperatura de cor: 3000K
Fluxo luminoso: 2400lm



Arpoador



Pendente
Arpoador
BD002R

Material: metal e acrílico
Cor: preto e transparente
Tensão: bivolt
Potência: 14X3W (42W)
Soquete: LED
Medida: 80cm x 37cm x 15.2cm
Temperatura de cor: 3000K
Fluxo luminoso: 2520lm

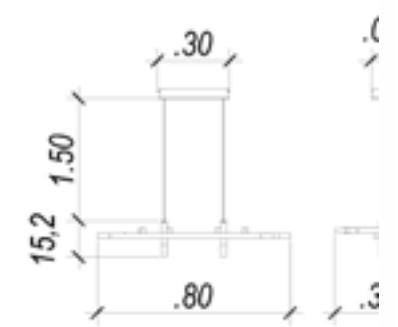

Pendente
Arpoador
BD002Q

Material: metal e acrílico
Cor: preto e transparente
Tensão: bivolt
Potência: 23X3W (69W)
Soquete: LED
Medida: 63.8cm x 59.8cm x 38.4cm
Temperatura de cor: 3000K
Fluxo luminoso: 4140lm

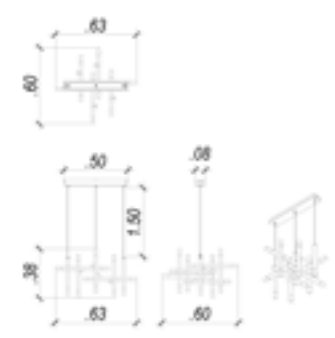

Arandela
Arpoador
BD002A

Material: metal e acrílico
Cor: preto e transparente
Tensão: bivolt
Potência: 8X3W (24W)
Soquete: LED
Medida: 10cm x 48.9cm x 48.1cm
Temperatura de cor: 3000K
Fluxo luminoso: 1440lm

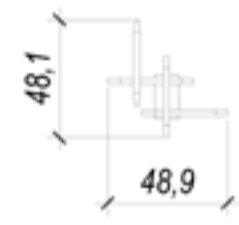

Glitter

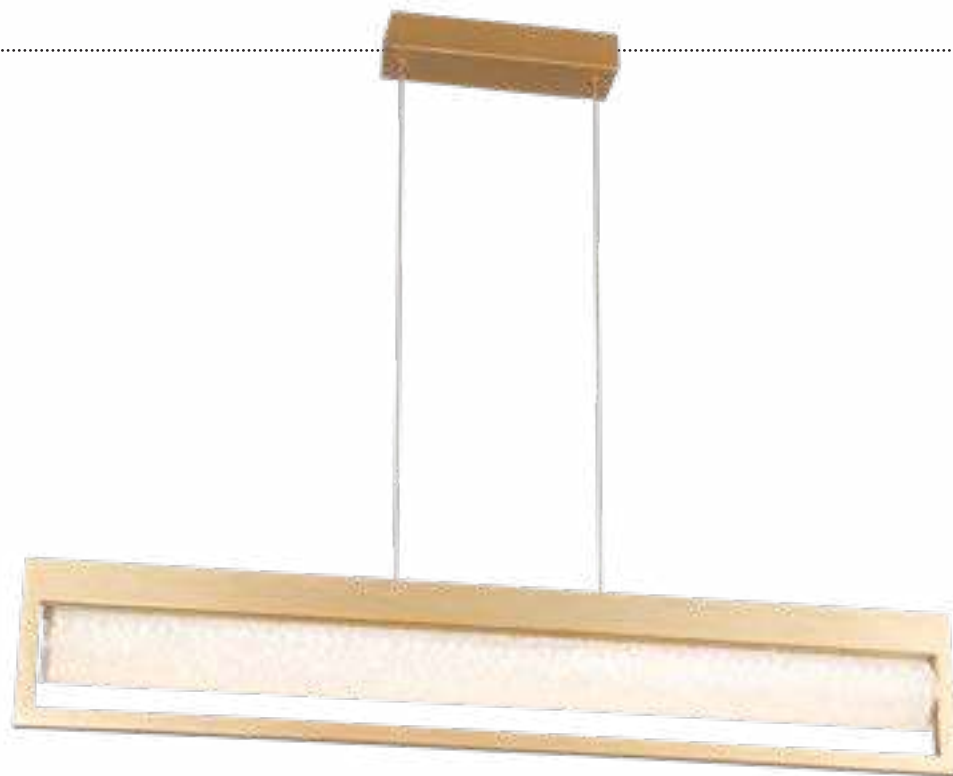

Pendente

Glitter

HC009S

Material: metal cristal e vidro
Cor: dourado e transparente
Tensão: bivolt
Potência: 1X20W
Soquete: LED
Medida: 6cm x 76cm x 13.5cm
Temperatura de cor: 3000K
Fluxo luminoso: 1000lm

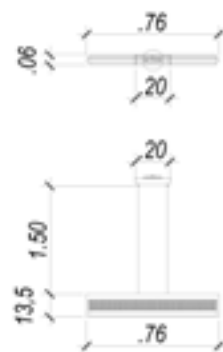

Arandela

Glitter

HC008

Material: metal cristal e vidro
Cor: dourado e transparente
Tensão: bivolt
Potência: 1X8W
Soquete: LED
Medida: 12cm x 35cm x 17.5cm
Temperatura de cor: 3000K
Fluxo luminoso: 400lm

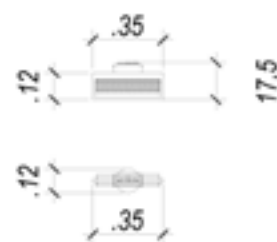

Pendente

Glitter

HC009L

Material: metal cristal e vidro
Cor: dourado e transparente
Tensão: bivolt
Potência: 1X40W
Soquete: LED
Medida: 16cm x 85cm x 71cm
Temperatura de cor: 3000K
Fluxo luminoso: 2000lm

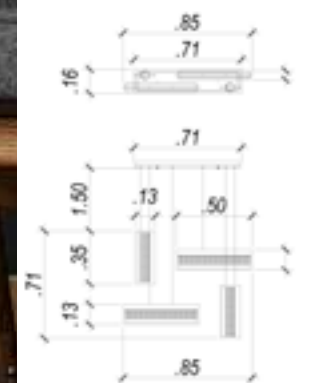

Candel



Pendente
Candel
JJ001

Material: metal e acrílico
Cor: french gold e branco
Tensão: bivolt
Potência: 18X2W (36W)
Soquete: LED
Medida: Ø62cm x10.5cm
Temperatura de cor: 3000K
Fluxo luminoso: 2880lm



Pendente
Candel
JJ002

Material: metal e acrílico
Cor: french gold e branco
Tensão: bivolt
Potência: 42X2W (84W)
Soquete: LED
Medida: Ø82cm x36cm
Temperatura de cor: 3000K
Fluxo luminoso: 6720lm



Pendente
Candel
JJ003

Material: metal e acrílico
Cor: french gold e branco
Tensão: bivolt
Potência: 72X2W (144W)
Soquete: LED
Medida: Ø100cm x61cm
Temperatura de cor: 3000K
Fluxo luminoso: 11520lm



Otto

Pendente
Otto
J0006G

Material: metal e vidro
Cor: french gold e transparente
Tensão: bivolt
Potência: 1X9W
Soquete: LED
Medida: Ø19cm x 11cm
Temperatura de cor: 3000K
Fluxo luminoso: 450lm



Pendente
Otto
J0006E

Material: metal e vidro
Cor: cobre e transparente
Tensão: bivolt
Potência: 1X9W
Soquete: LED
Medida: Ø19cm x 11cm
Temperatura de cor: 3000K
Fluxo luminoso: 450lm

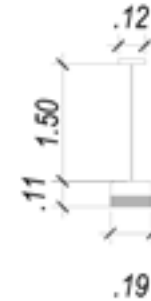

Pendente
Otto
J0007G

Material: metal e vidro
Cor: french gold e transparente
Tensão: bivolt
Potência: 1X15W
Soquete: LED
Medida: Ø31.5cm x 11cm
Temperatura de cor: 3000K
Fluxo luminoso: 750lm

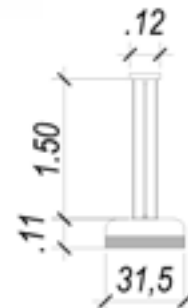

Pendente
Otto
J0007E

Material: metal e vidro
Cor: cobre e transparente
Tensão: bivolt
Potência: 1X15W
Soquete: LED
Medida: Ø31.5cm x 11cm
Temperatura de cor: 3000K
Fluxo luminoso: 750lm

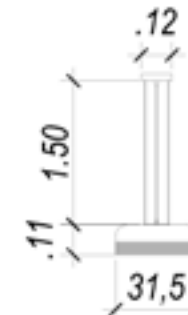

Palito

Pendente

Palito

CD015

Material: aço alumínio e acrílico
Cor: pale gold
Tensão: bivolt
Potência: 16 X 3,375W (54W)
Soquete: LED
Medida: 60cm x 90cm x 11cm
Temperatura de cor: 2700K
Fluxo luminoso: 3250lm

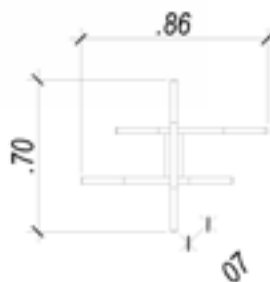
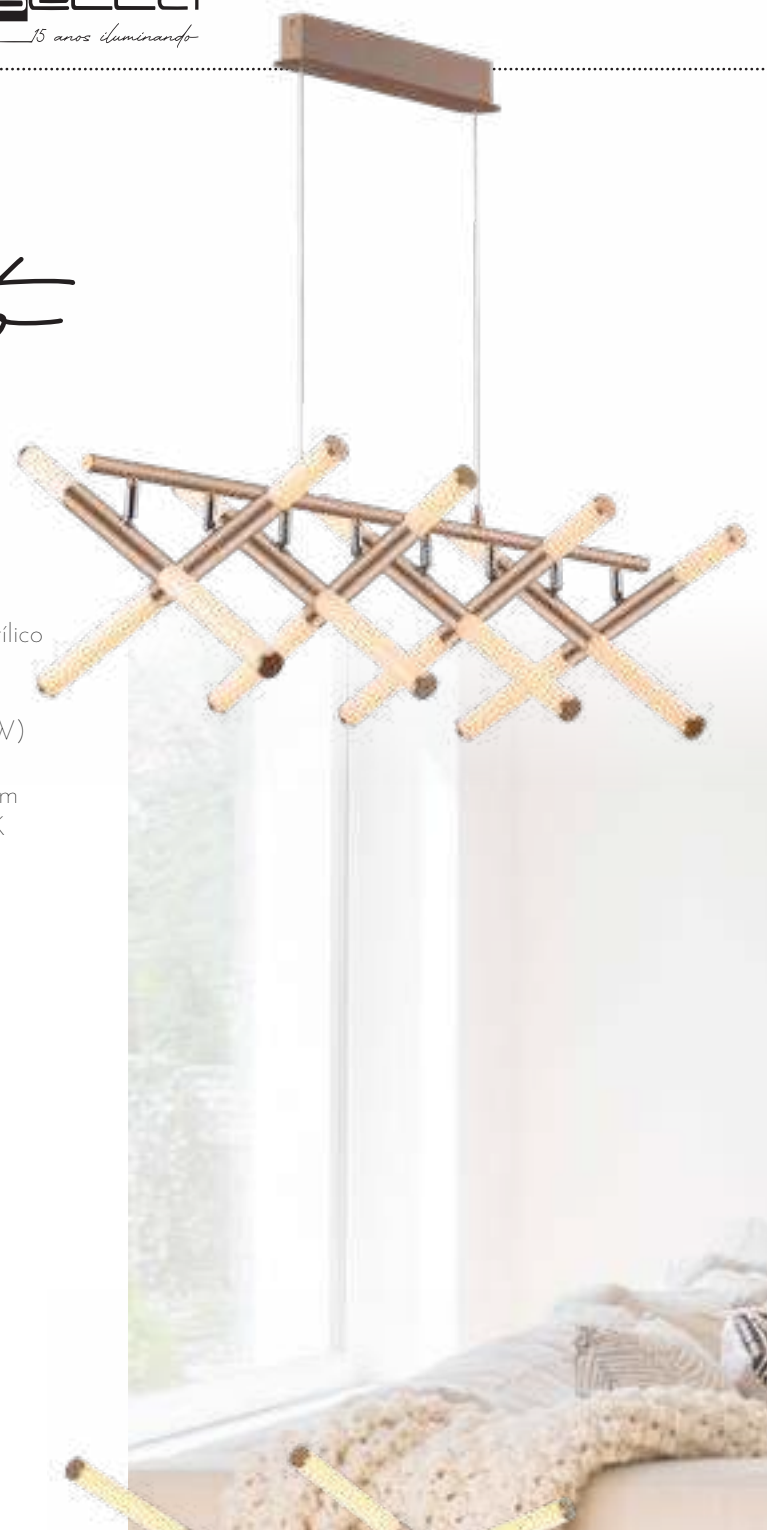
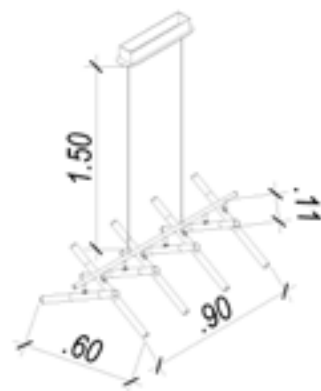

Plafon

Palito

CD017

Material: aço alumínio e acrílico
Cor: pale gold
Tensão: bivolt
Potência: 6X6W (36W)
Soquete: LED
Medida: 70cm x 86cm x 7cm
Temperatura de cor: 2700K
Fluxo luminoso: 1800lm



Pendente

Palito

CD014

Material: aço alumínio e acrílico
Cor: pale gold
Tensão: bivolt
Potência: 10X7,2W (72W)
Soquete: LED
Medida: 90cm x 90cm x 23cm
Temperatura de cor: 2700K
Fluxo luminoso: 3600lm

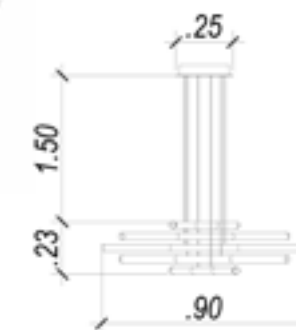

Plafon

Palito

CD016

Material: aço alumínio e acrílico
Cor: pale gold
Tensão: bivolt
Potência: 4X6W (24W)
Soquete: LED
Medida: 70cm x 70cm x 7cm
Temperatura de cor: 2700K
Fluxo luminoso: 1200lm

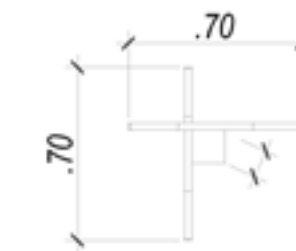

Petra

Pendente

Petra

OC009

Material: metal e cristal de rocha
Cor: dourado e transparente
Tensão: bivolt
Potência: 3X6W (18W)
Soquete: LED
Medida: Ø54cm x31cm
Temperatura de cor: 3000K
Fluxo luminoso: 900lm

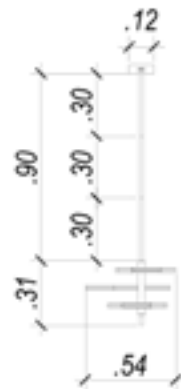

Arandela

Petra

OC004S

Material: metal e cristal de rocha
Cor: dourado e transparente
Tensão: bivolt
Potência: 1X3W
Soquete: LED
Medida: 12cm x 11cm x42cm
Temperatura de cor: 3000K
Fluxo luminoso: 150lm



Pendente

Petra

OC001S

Material: metal e cristal de rocha
Cor: dourado e transparente
Tensão: bivolt
Potência: 1X3W
Soquete: LED
Medida: Ø12cm x 44cm
Temperatura de cor: 3000K
Fluxo luminoso: 150lm



Pendente

Petra

OC001M

Material: metal e cristal de rocha
Cor: dourado e transparente
Tensão: bivolt
Potência: 3X3W (9W)
Soquete: LED
Medida: Ø30cm x44cm
Temperatura de cor: 3000K
Fluxo luminoso: 450lm



Arandela

Petra

OC004M

Material: metal e cristal de rocha
Cor: dourado e transparente
Tensão: bivolt
Potência: 2X3W (6W)
Soquete: LED
Medida: 12cm x 11cm x53cm
Temperatura de cor: 3000K
Fluxo luminoso: 300lm





Pendente
Petra
OC001L

Material: metal, cristal de rocha
Cor: dourado e transparente
Tensão: bivolt
Potência: 6X3W (18W)
Soquete: LED
Medida: Ø40cm x 44cm
Temperatura de cor: 3000K
Fluxo luminoso: 900lm



Pendente
Petra
OC001R

Material: metal, cristal de rocha
Cor: dourado e transparente
Tensão: bivolt
Potência: 5X3W (15W)
Soquete: LED
Medida: 12cm x 60cm x 44cm
Temperatura de cor: 3000K
Fluxo luminoso: 750lm



Clair

Pendente
Clair
JJ011

Material: metal e acrílico
Cor: sand gold e branco
Tensão: bivolt
Potência: 16X2W (32W)
Soquete: LED
Medida: 8cm x 105cm x 20cm
Temperatura de cor: 3000K
Fluxo luminoso: 3840lm

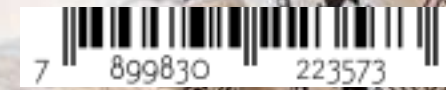

Arandela
Clair
JJ012

Material: metal e acrílico
Cor: sand gold e branco
Tensão: bivolt
Potência: 6X2W (12W)
Soquete: LED
Medida: 15.5cm x 36.5cm x 9cm
Temperatura de cor: 3000K
Fluxo luminoso: 240lm





Archi



Pendente
Archi
CD001S

Material: metal
Cor: bronze
Tensão: bivolt
Potência: 5X7W (35W)
Soquete: LED
Medida: 16cm x 120cm x 70cm
Temperatura de cor: 3000K
Fluxo luminoso: 2600lm



Pendente
Archi
CD001M

Material: metal
Cor: bronze
Tensão: bivolt
Potência: 7X7W (49W)
Soquete: LED
Medida: 16cm x 174cm x 70cm
Temperatura de cor: 3000K
Fluxo luminoso: 3640lm



Tubi

Pendente
Tubi
CD002S

Material: metal
Cor: cobre e preto
Tensão: bivolt
Potência: 5X7W (35W)
Soquete: LED
Medida: 4cm x 78cm x 20cm
Temperatura de cor: 3000K
Fluxo luminoso: 2600lm



Pendente
Tubi
CD002M

Material: metal
Cor: cobre e preto
Tensão: bivolt
Potência: 7X7W (49W)
Soquete: LED
Medida: 4cm x 105cm x 20cm
Temperatura de cor: 3000K
Fluxo luminoso: 3640lm



Poema

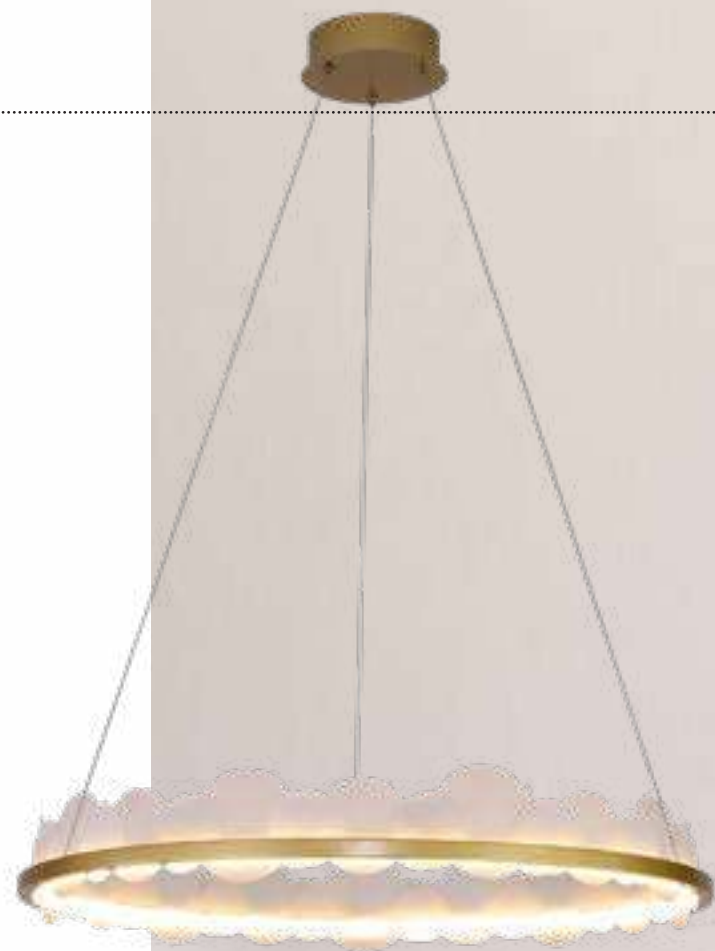

Pendente
Poema
EG004
Material: metal e acrílico
Cor: dourado e branco
Tensão: bivolt
Potência: 1X34W
Soquete: LED
Medida: 6cm x 100cm x 12cm
Temperatura de cor: 3000K
Fluxo luminoso: 1700lm

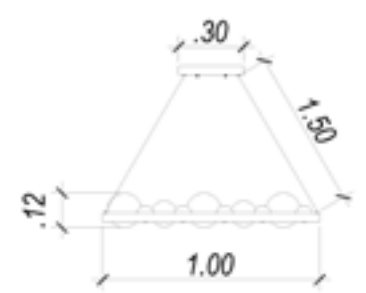

Pendente
Poema
EG003

Material: metal e acrílico
Cor: dourado e branco
Tensão: bivolt
Potência: 1 X 45W
Soquete: LED
Medida: Ø80cm x 12cm
Temperatura de cor: 3000K
Fluxo luminoso: 2250lm

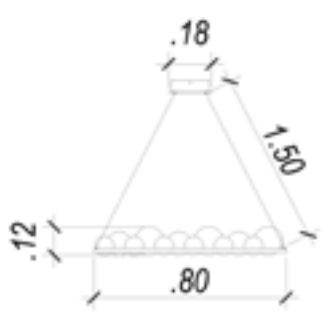

Arandela
Poema
EG005

Material: metal e acrílico
Cor: dourado e branco
Tensão: bivolt
Potência: 1X10W
Soquete: LED
Medida: 6cm x 30cm x 9cm
Temperatura de cor: 3000K
Fluxo luminoso: 500lm

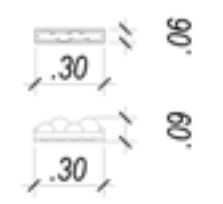



Sarau

Pendente
Sarau
HS002

Material: alumínio
Cor: dourado
Tensão: bivolt
Potência: 32X1,4W (44,8W)
Soquete: LED
Medida: Ø82,5cm x19,8cm
Temperatura de cor: 3000K
Fluxo luminoso: 2800lm

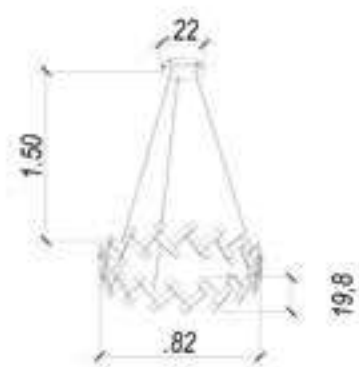

Pendente
Sarau
HS001

Material: alumínio
Cor: dourado
Tensão: bivolt
Potência: 12X2W (24W)
Soquete: LED
Medida: 92,5cm x 19cm x1,5cm
Temperatura de cor: 3000K
Fluxo luminoso: 1300lm

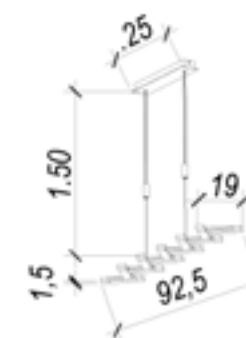

Arandela
Sarau
HS003

Material: alumínio
Cor: dourado
Tensão: bivolt
Potência: 8X2W (16W)
Soquete: LED
Medida: 62cm x 7cm x19cm
Temperatura de cor: 3000K
Fluxo luminoso: 850lm

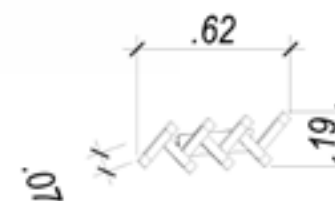



Bossa Nova

Pendente
Bossa Nova
OC006S

Material: metal e vidro
Cor: dourado e branco
Tensão: bivolt
Potência: 1X10W
Soquete: LED
Medida: Ø12cm x 60cm
Temperatura de cor: 3000K
Fluxo luminoso: 500lm



Pendente
Bossa Nova
OC006

Material: metal e vidro
Cor: dourado e branco
Tensão: bivolt
Potência: 1X20W
Soquete: LED
Medida: Ø12cm x 90cm
Temperatura de cor: 3000K
Fluxo luminoso: 1000lm



Pendente
Bossa Nova
OC007

Material: metal e vidro
Cor: dourado e branco
Tensão: bivolt
Potência: 20W + 7W (27W)
Soquete: LED
Medida: Ø12cm x 90cm e 90cm x 60cm
Temperatura de cor: 3000K
Fluxo luminoso: 1350lm





Circolo

Pendente
Circolo

BBO22

Material: metal e acrílico
Cor: french gold e branco
Tensão: bivolt
Potência: 1X43,2W
Soquete: LED
Medida: Ø60cm
Temperatura de cor: 3000K
Fluxo luminoso: 2160lm

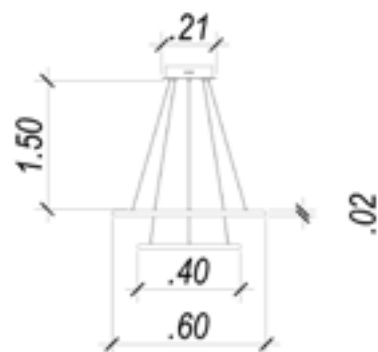

*Aros
Giratórios*

Plafon
Circolo
BBO20

Material: metal e acrílico
Cor: french gold e branco
Tensão: bivolt
Potência: 1X54W
Soquete: LED
Medida: 49cm x 86cm x 20cm
Temperatura de cor: 3000K
Fluxo luminoso: 2700lm

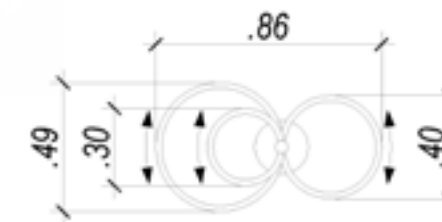

Plafon
Circolo
BBO21

Material: metal e acrílico
Cor: french gold e branco
Tensão: bivolt
Potência: 1X32,4W
Soquete: LED
Medida: 39cm x 69cm x 15cm
Temperatura de cor: 3000K
Fluxo luminoso: 1620lm

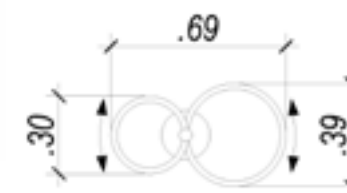

Dende

Pendente

Dende

JJ017

Material: metal e vidro
Cor: dourado e preto
Tensão: bivolt
Potência: 5X13W (65W)
Soquete: LED
Medida: 15cm x 95cm x15cm
Temperatura de cor: 3000K
Fluxo luminoso: 5200lm

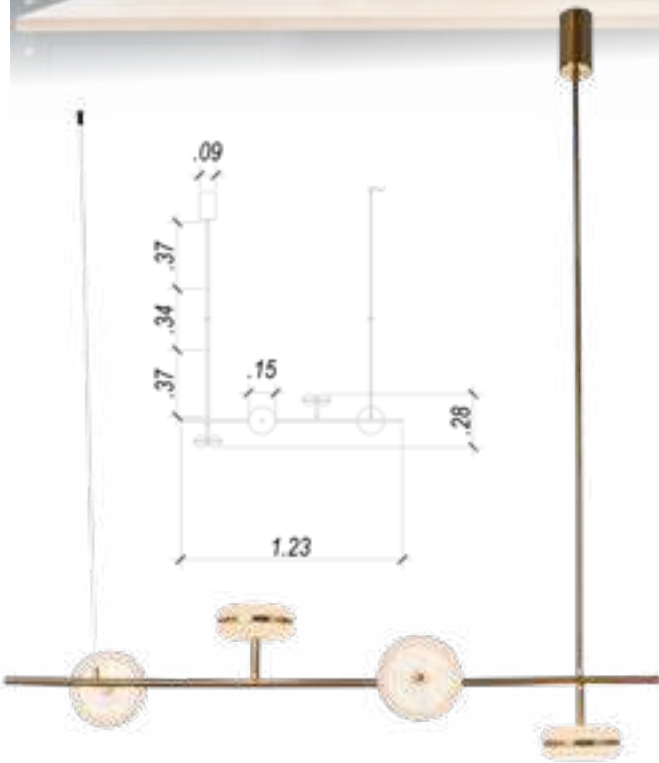
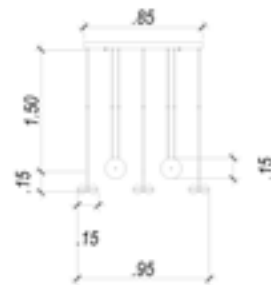

Pendente

Dende

JJ019

Material: metal e vidro
Cor: dourado
Tensão: bivolt
Potência: 4X13W (52W)
Soquete: LED
Medida: 123cm x 28cm x15cm
Temperatura de cor: 3000K
Fluxo luminoso: 4160lm

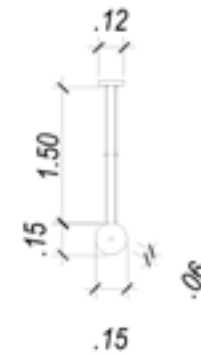

Pendente

Dende

JJ016

Material: metal e vidro
Cor: dourado e preto
Tensão: bivolt
Potência: 1X13W
Soquete: LED
Medida: 6cm x 15cm x15cm
Temperatura de cor: 3000K
Fluxo luminoso: 1040lm



Pendente

Dende

JJ020

Material: metal e vidro
Cor: dourado
Tensão: bivolt
Potência: 4X13W (52W)
Soquete: LED
Medida: 28cm x 28cm x122.5cm
Temperatura de cor: 3000K
Fluxo luminoso: 4160lm



Arandela

Dende

JJ018

Material: metal e vidro
Cor: dourado e preto
Tensão: bivolt
Potência: 1X13W
Soquete: LED
Medida: 9cm x 15cm x15cm
Temperatura de cor: 3000K
Fluxo luminoso: 1040lm

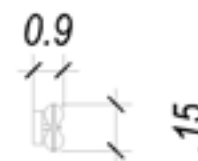



Cordel

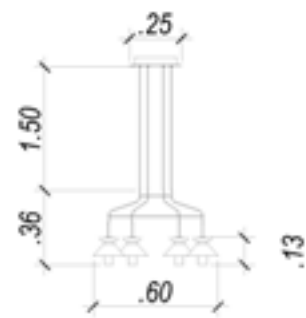

Pendente

Cordel

CD008

Material: aço alumínio e acrílico
Cor: pale gold
Tensão: bivolt
Potência: 6X5W + 6X2W (42W)
Soquete: LED
Medida: 60cm x 60cm x13cm
Temperatura de cor: 2700K
Fluxo luminoso: 2100lm

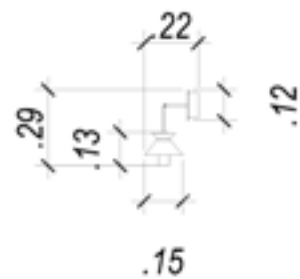

Arandela

Cordel

CD009

Material: aço alumínio e acrílico
Cor: pale gold
Tensão: bivolt
Potência: 5W + 1W (6W)
Soquete: LED
Medida: 15cm x 22cm x13cm
Temperatura de cor: 2700K
Fluxo luminoso: 300lm

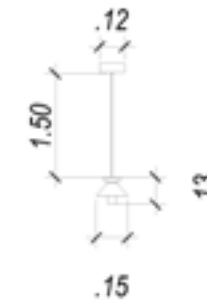

Pendente

Cordel

CD012

Material: aço alumínio e acrílico
Cor: pale gold
Tensão: bivolt
Potência: 5W + 2W (7W)
Soquete: LED
Medida: Ø15cm x13cm
Temperatura de cor: 2700K
Fluxo luminoso: 350lm



Pendente

Cordel

CD013

Material: aço alumínio e acrílico
Cor: preto
Tensão: bivolt
Potência: 5W + 2W (7W)
Soquete: LED
Medida: Ø15cm x13cm
Temperatura de cor: 2700K
Fluxo luminoso: 350lm

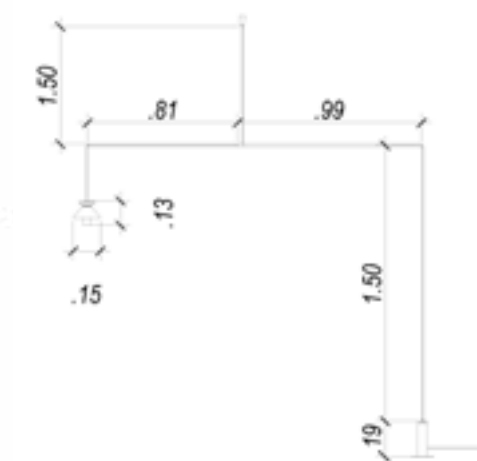
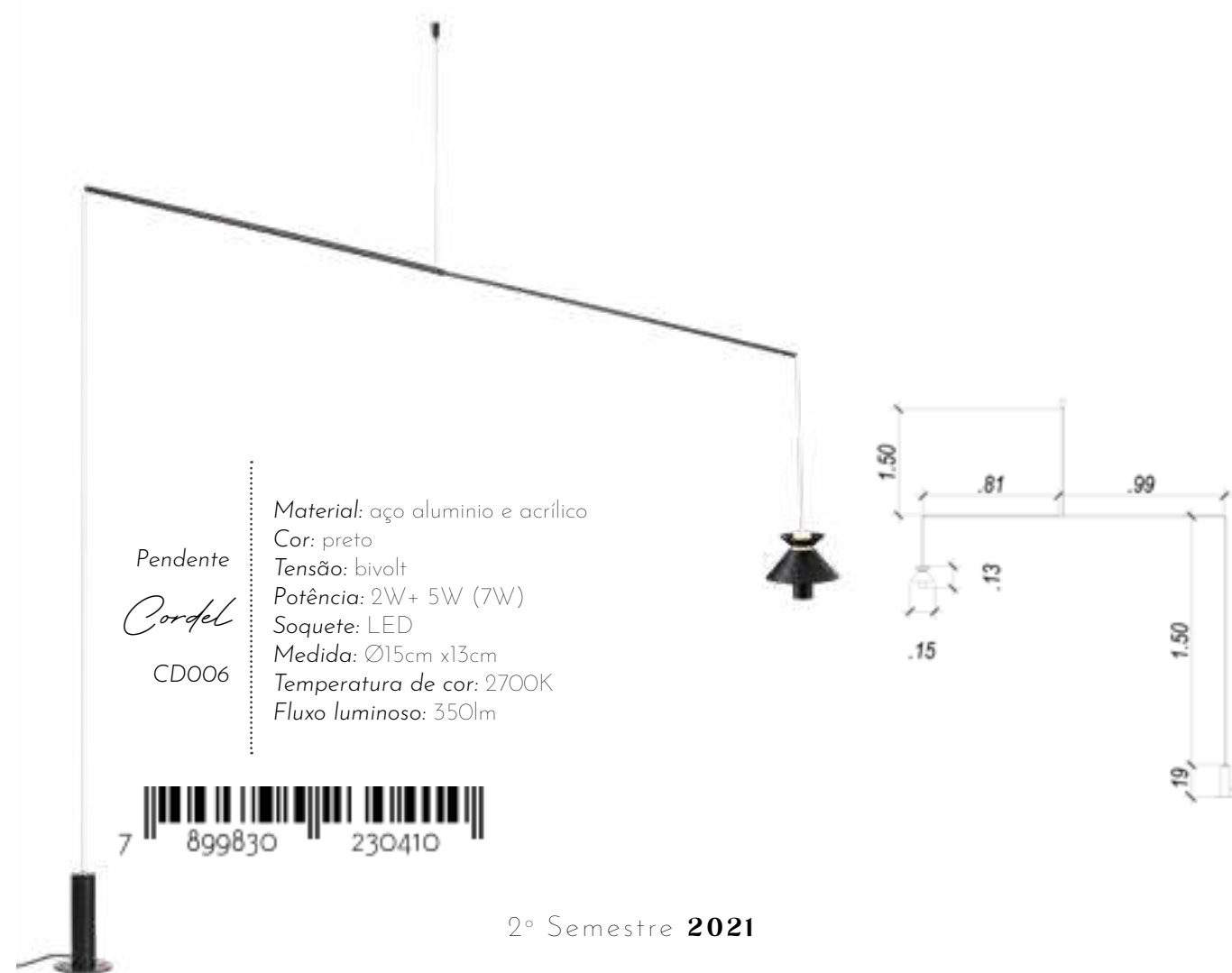

Pendente

Cordel

CD006

Material: aço alumínio e acrílico
Cor: preto
Tensão: bivolt
Potência: 2W + 5W (7W)
Soquete: LED
Medida: Ø15cm x13cm
Temperatura de cor: 2700K
Fluxo luminoso: 350lm



Água



Pendente
Água
RE015S

Material: metal e vidro
Cor: nickel transparente e branco
Tensão: bivolt
Potência: 1X7W
Soquete: LED
Medida: Ø4.5cm x38.5cm
Temperatura de cor: 3000K
Fluxo luminoso: 400lm



Arandela
Água
RE016

Material: metal e vidro
Cor: nickel transparente e branco
Tensão: bivolt
Potência: 1X7W
Soquete: LED
Medida: 23cm x 7cm x54cm
Temperatura de cor: 3000K
Fluxo luminoso: 400lm

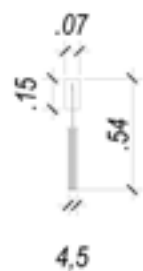

Pendente
Água
RE015L

Material: metal e vidro
Cor: nickel transparente e branco
Tensão: bivolt
Potência: 6X7W (42W)
Soquete: LED
Medida: Ø60cm x38.5cm
Temperatura de cor: 3000K
Fluxo luminoso: 2040lm

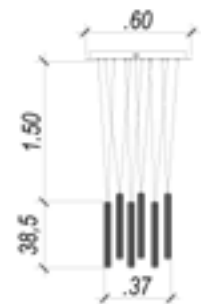

Pendente
Água
RE015M

Material: metal e vidro
Cor: nickel transparente e branco
Tensão: bivolt
Potência: 3X7W (21W)
Soquete: LED
Medida: Ø40cm x38.5cm
Temperatura de cor: 3000K
Fluxo luminoso: 975lm

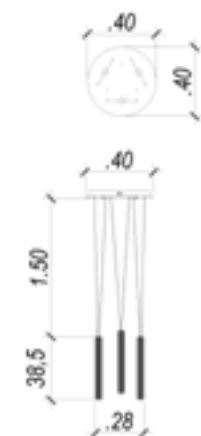



Patuá

Pendente

Patuá

CD005

Material: metal e acrílico
Cor: branco e marrom
Tensão: bivolt
Potência: 12W+18W+24W (54W)
Soquete: LED
Medida: 81cm x 9cm x 66cm
Temperatura de cor: 2700K
Fluxo luminoso: 2311lm

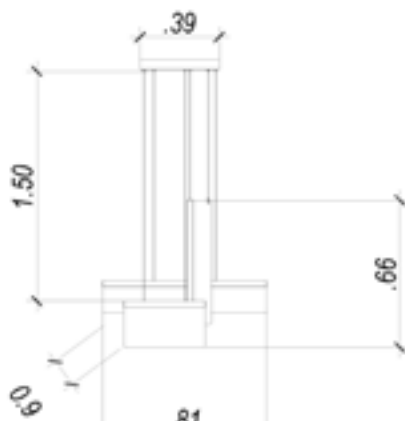

Loio

Pendente

Loio

BBO08N

Material: metal e vidro
Cor: nickel e fume
Tensão: bivolt
Potência: 1X8,5W
Soquete: LED
Medida: Ø22cm x 19cm
Temperatura de cor: 3000K
Fluxo luminoso: 850lm



Plexus

Pendente

Plexus

RE002S

Material: metal
Cor: dourado e preto
Tensão: bivolt
Potência: 4X4,6W (18,4W)
Soquete: LED
Medida: Ø95cm x 115cm
Temperatura de cor: 3000K
Fluxo luminoso: 1400lm



Disko

Pendente

Disko

FO014A

Material: metal e vidro
Cor: dourado e ambar
Tensão: bivolt
Potência: 1X8W
Soquete: LED
Medida: Ø23cm x 10cm
Temperatura de cor: 3000K
Fluxo luminoso: 400lm



Pendente

Disko

FO014S

Material: metal e vidro
Cor: preto e fume
Tensão: bivolt
Potência: 1X8W
Soquete: LED
Medida: Ø23cm x 10cm
Temperatura de cor: 3000K
Fluxo luminoso: 400lm



Abajur

Disko

FO015A

Material: metal e vidro
Cor: dourado e ambar
Tensão: bivolt
Potência: 1X8W
Soquete: LED
Medida: Ø23cm x 42cm
Temperatura de cor: 3000K
Fluxo luminoso: 400lm



Arandela

Disko

FO016A

Material: metal e vidro
Cor: dourado e ambar
Tensão: bivolt
Potência: 1X8W
Soquete: LED
Medida: Ø23cm x 10cm
Temperatura de cor: 3000K
Fluxo luminoso: 400lm



Abajur

Disko

FO015S

Material: metal e vidro
Cor: preto e fume
Tensão: bivolt
Potência: 1X8W
Soquete: LED
Medida: Ø23cm x 42cm
Temperatura de cor: 3000K
Fluxo luminoso: 400lm



Arandela

Disko

FO016S

Material: metal e vidro
Cor: preto e fume
Tensão: bivolt
Potência: 1X8W
Soquete: LED
Medida: Ø23cm x 10cm
Temperatura de cor: 3000K
Fluxo luminoso: 400lm



Fluire



Pendente

Fluire

SB001

Material: metal
Cor: dourado
Tensão: bivolt
Potência: 1X30W
Soquete: LED
Medida: 55cm x 58cm x 24cm
Temperatura de cor: 3000K
Fluxo luminoso: 3300lm



Coluna

Fluire

SB003

Material: metal
Cor: dourado
Tensão: bivolt
Potência: 1X30W
Soquete: LED
Medida: Ø23cm x 115cm
Temperatura de cor: 3000K
Fluxo luminoso: 3300lm



Abajur

Fluire

SB002

Material: metal
Cor: dourado
Tensão: bivolt
Potência: 1X20W
Soquete: LED
Medida: 22cm x 23cm x 45cm
Temperatura de cor: 3000K
Fluxo luminoso: 2200lm



Pendente

Fluire

RE005

Material: metal
Cor: dourado
Tensão: bivolt
Potência: 1X30W
Soquete: LED
Medida: Ø28cm x 74cm
Temperatura de cor: 3000K
Fluxo luminoso: 1800lm



Pendente

Fluire

RE006

Material: metal
Cor: dourado
Tensão: bivolt
Potência: 1X45W
Soquete: LED
Medida: 25cm x 100cm x 30cm
Temperatura de cor: 3000K
Fluxo luminoso: 2700lm



Arandela

Fluire

RE007

Material: metal
Cor: dourado
Tensão: bivolt
Potência: 1X12W
Soquete: LED
Medida: 30cm x 20cm x 40cm
Temperatura de cor: 3000K
Fluxo luminoso: 720lm





Pendente

Flow

SB008

Material: metal
Cor: preto
Tensão: bivolt
Potência: 1X30W
Soquete: LED
Medida: 33cm x 93cm x 26cm
Temperatura de cor: 3000K
Fluxo luminoso: 3300lm



Arandela

Flow

SB007

Material: metal
Cor: preto
Tensão: bivolt
Potência: 1X12W
Soquete: LED
Medida: 23cm x 38cm x 12cm
Temperatura de cor: 3000K
Fluxo luminoso: 1320lm



Coluna

Flow

SB005

Material: metal
Cor: preto
Tensão: bivolt
Potência: 1X35W
Soquete: LED
Medida: 23cm x 32cm x 148cm
Temperatura de cor: 3000K
Fluxo luminoso: 3850lm



Abajur

Flow

SB006

Material: metal
Cor: preto
Tensão: bivolt
Potência: 1X12W
Soquete: LED
Medida: Ø18cm x 38cm
Temperatura de cor: 3000K
Fluxo luminoso: 1320lm



Goccia



Pendente
Goccia
OC002S

Material: metal e vidro
Cor: dourado e transparente
Tensão: bivolt
Potência: 1X3W
Soquete: LED
Medida: Ø12cm x 41cm
Temperatura de cor: 3000K
Fluxo luminoso: 160lm



Pendente
Goccia
OC002L

Material: metal e vidro
Cor: dourado e transparente
Tensão: bivolt
Potência: 6X3W (18W)
Soquete: LED
Medida: Ø40cm x 41cm
Temperatura de cor: 3000K
Fluxo luminoso: 960lm



Arandela
Goccia
OC005

Material: metal e vidro
Cor: dourado e transparente
Tensão: bivolt
Potência: 1X3W
Soquete: LED
Medida: 12cm x 11cm x 42cm
Temperatura de cor: 3000K
Fluxo luminoso: 195lm



Pendente
Goccia
OC002M

Material: metal e vidro
Cor: dourado e transparente
Tensão: bivolt
Potência: 3X3W (9W)
Soquete: LED
Medida: Ø30cm x 41cm
Temperatura de cor: 3000K
Fluxo luminoso: 480lm



Lampe

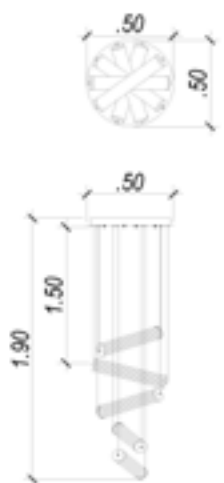

Pendente
Lampe
HC002

Material: metal acrílico e vidro
Cor: bronze e transparente
Tensão: bivolt
Potência: 5X15W (75W)
Soquete: LED
Medida: Ø50cm x190cm
Temperatura de cor: 3000K
Fluxo luminoso: 3750lm



Arandela
Lampe
HC003

Material: metal acrílico e vidro
Cor: bronze e transparente
Tensão: bivolt
Potência: 1X8W
Soquete: LED
Medida: 10.5cm x 38cm x11.5cm
Temperatura de cor: 3000K
Fluxo luminoso: 400lm

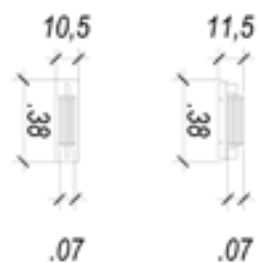

Pendente
Lampe
HC001S

Material: metal acrílico e vidro
Cor: bronze e transparente
Tensão: bivolt
Potência: 1X23W
Soquete: LED
Medida: 7.35cm x 65cm x 7.35cm
Temperatura de cor: 3000K
Fluxo luminoso: 1150lm

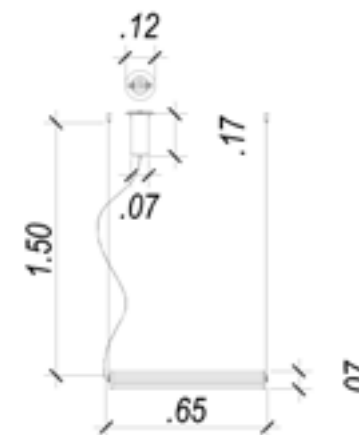

Pendente
Lampe
HC001L

Material: metal acrílico e vidro
Cor: bronze e transparente
Tensão: bivolt
Potência: 1X45W
Soquete: LED
Medida: 7.35cm x 125cm x 7.35cm
Temperatura de cor: 3000K
Fluxo luminoso: 2250lm

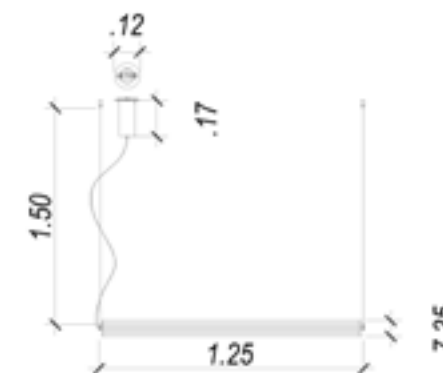

Losanghe



Pendente
Losanghe
EG002S

Material: metal e acrílico
Cor: dourado e branco
Tensão: bivolt
Potência: 4X13W (52W)
Soquete: LED
Medida: Ø60cm x 17.9cm
Temperatura de cor: 3000K
Fluxo luminoso: 2600lm

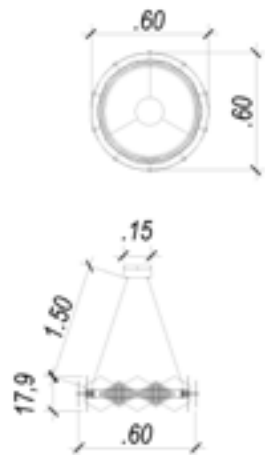

Pendente
Losanghe
EG002L

Material: metal e acrílico
Cor: dourado e branco
Tensão: bivolt
Potência: 4X17W (68W)
Soquete: LED
Medida: Ø80cm x 17.9cm
Temperatura de cor: 3000K
Fluxo luminoso: 3400lm

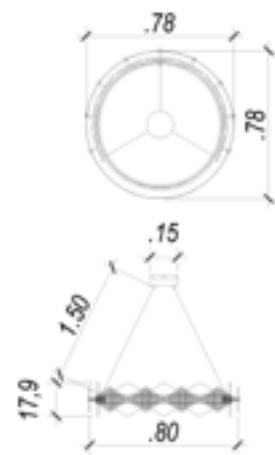

Fita



Pendente
Fita
BB018

Material: alumínio
Cor: sand gold
Tensão: bivolt
Potência: 1X66W
Soquete: LED
Medida: Ø60cm x 31cm
Temperatura de cor: 3000K
Fluxo luminoso: 3300lm



Plafon
Fita
BB019

Material: alumínio
Cor: sand gold
Tensão: bivolt
Potência: 1X36W
Soquete: LED
Medida: Ø46cm x 28.5cm
Temperatura de cor: 3000K
Fluxo luminoso: 1800lm

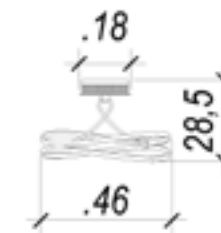



Lampião



Pendente
Lampião
RBO02

Material: metal e vidro
Cor: dourado e transparente
Tensão: bivolt
Potência: 1X5W
Soquete: LED
Medida: Ø10cm x 52cm
Temperatura de cor: 3000K
Fluxo luminoso: 250lm

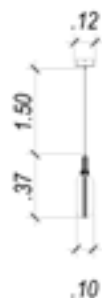

Pendente
Lampião
RBO01

Material: metal e vidro
Cor: dourado e transparente
Tensão: bivolt
Potência: 1X5W
Soquete: LED
Medida: Ø10cm x 37cm
Temperatura de cor: 3000K
Fluxo luminoso: 250lm



Ghianda



Pendente
Ghianda
AC007E

Material: metal e vidro
Cor: french gold e transparente
Tensão: bivolt
Potência: 1X3W
Soquete: LED
Medida: Ø30cm x 46.5cm
Temperatura de cor: 3000K
Fluxo luminoso: 300lm



Pendente
Ghianda
AC007C

Material: metal e vidro
Cor: cromado e transparente
Tensão: bivolt
Potência: 1X3W
Soquete: LED
Medida: Ø30cm x 46.5cm
Temperatura de cor: 3000K
Fluxo luminoso: 300lm



Pendente
Ghianda
AC007G

Material: metal e vidro
Cor: rose gold e transparente
Tensão: bivolt
Potência: 1X3W
Soquete: LED
Medida: Ø30cm x 46.5cm
Temperatura de cor: 3000K
Fluxo luminoso: 300lm





Pendente
Ludique
EG006

Material: metal e acrílico
Cor: dourado transp. e branco
Tensão: bivolt
Potência: 1X5W
Soquete: LED
Medida: Ø10cm x6cm
Temperatura de cor: 3000K
Fluxo luminoso: 250lm

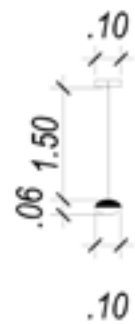

Pendente
Ludique
EG007

Material: metal e acrílico
Cor: dourado transp. e branco
Tensão: bivolt
Potência: 10X5W (50W)
Soquete: LED
Medida: Ø66cm x87cm
Temperatura de cor: 3000K
Fluxo luminoso: 2500lm

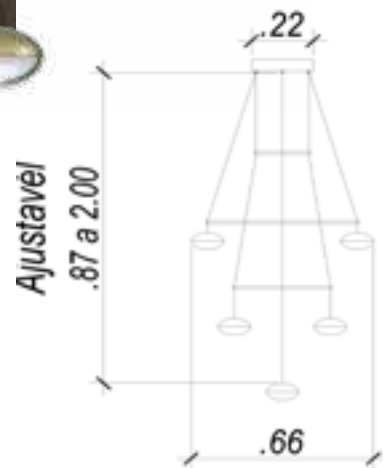

Pendente
Lanterna
HC010

Material: metal e acrílico
Cor: dourado e branco
Tensão: bivolt
Potência: 1X16W
Soquete: LED
Medida: Ø50cm x 32cm
Temperatura de cor: 3000K
Fluxo luminoso: 800lm

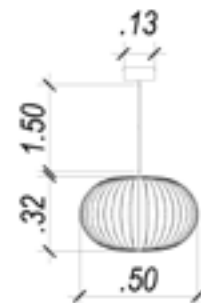

Lanterna



Plafon
Lanterna
HC011

Material: metal e acrílico
Cor: dourado e branco
Tensão: bivolt
Potência: 1X12W
Soquete: LED
Medida: Ø40cm x25cm
Temperatura de cor: 3000K
Fluxo luminoso: 600lm

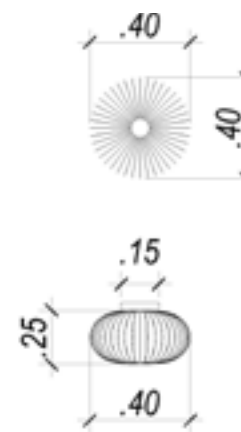



Aral

Pendente
Aral
KE006W

Material: metal
Cor: branco
Tensão: bivolt
Potência: 2X4W (8W)
Soquete: LED
Medida: Ø53cm x55cm
Temperatura de cor: 3000K
Fluxo luminoso: 900lm



Pendente
Aral
KE006B

Material: metal
Cor: preto
Tensão: bivolt
Potência: 2X4W (8W)
Soquete: LED
Medida: Ø53cm x55cm
Temperatura de cor: 3000K
Fluxo luminoso: 900lm



Pendente
Aral
KE007B

Material: metal
Cor: preto
Tensão: bivolt
Potência: 2X4W (8W)
Soquete: LED
Medida: Ø33cm x70cm
Temperatura de cor: 3000K
Fluxo luminoso: 900lm



Pendente
Aral
KE007W

Material: metal
Cor: branco
Tensão: bivolt
Potência: 2X4W (8W)
Soquete: LED
Medida: Ø33cm x70cm
Temperatura de cor: 3000K
Fluxo luminoso: 900lm



Lumina

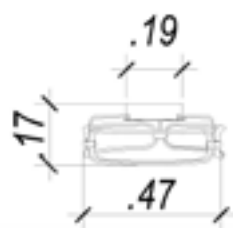

Plafon
Lumina
BB016SG

Material: alumínio
Cor: french gold
Tensão: bivolt
Potência: 1X35W
Soquete: LED
Medida: Ø47cm x 17cm
Temperatura de cor: 3000K
Fluxo luminoso: 1750lm

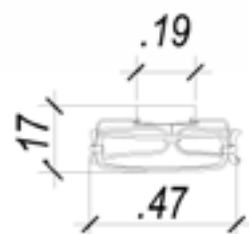

Plafon
Lumina
BB016SE

Material: alumínio
Cor: rose gold
Tensão: bivolt
Potência: 1X35W
Soquete: LED
Medida: Ø47cm x 17cm
Temperatura de cor: 3000K
Fluxo luminoso: 1750lm

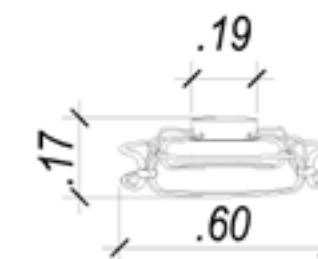
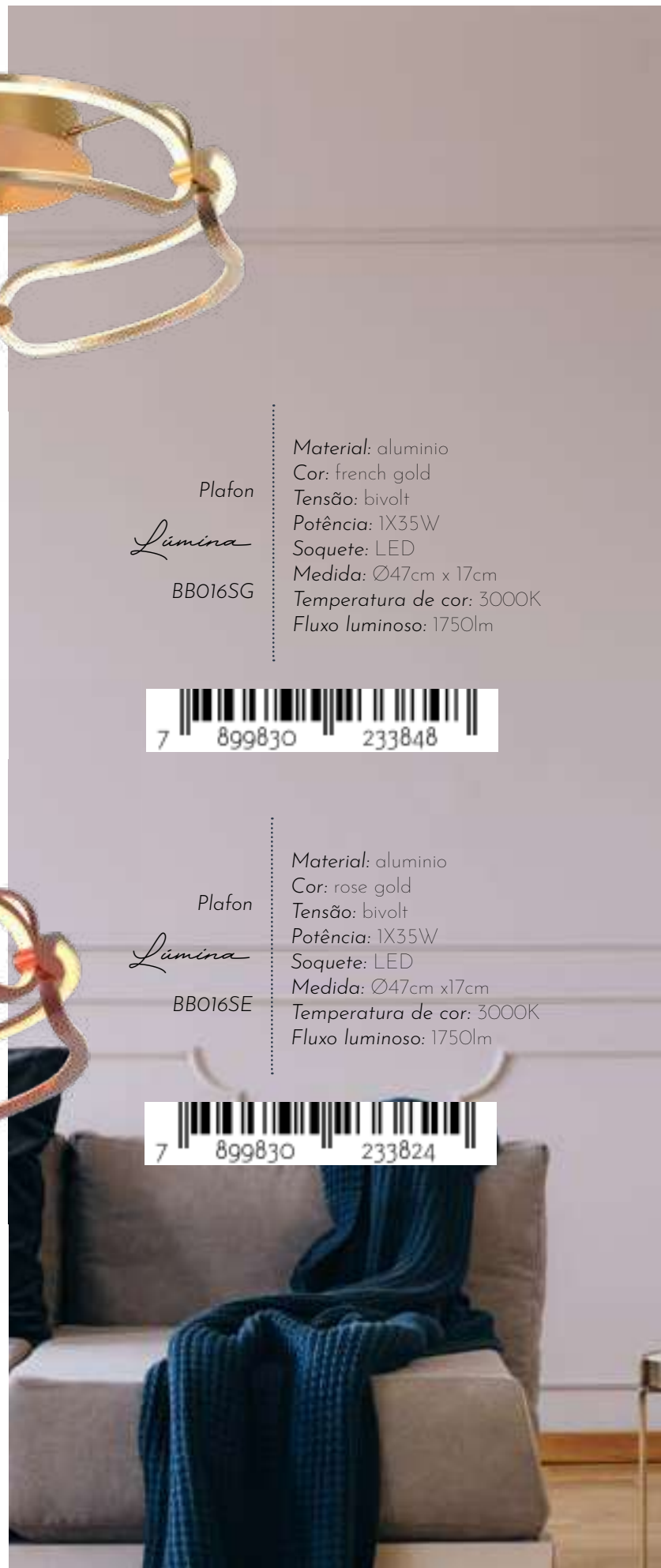

Plafon
Lumina
BB016LG

Material: alumínio
Cor: french gold
Tensão: bivolt
Potência: 1X45W
Soquete: LED
Medida: Ø60cm x 17cm
Temperatura de cor: 3000K
Fluxo luminoso: 2250lm

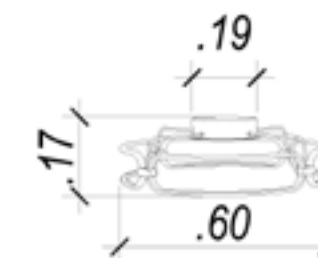
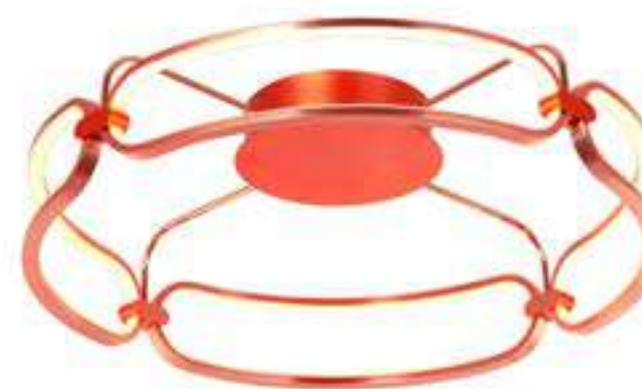

Plafon
Lumina
BB016LE

Material: alumínio
Cor: rose gold
Tensão: bivolt
Potência: 1X45W
Soquete: LED
Medida: Ø60cm x 17cm
Temperatura de cor: 3000K
Fluxo luminoso: 2250lm



Pendente
Lâmina
BB007G

Material: alumínio
Cor: french gold
Tensão: bivolt
Potência: 1X50W
Soquete: LED
Medida: Ø60cm x9.5cm
Temperatura de cor: 3000K
Fluxo luminoso: 2500lm



Pendente
Lâmina
BB006E

Material: alumínio
Cor: rose gold
Tensão: bivolt
Potência: 1X37W
Soquete: LED
Medida: Ø45cm x9.5cm
Temperatura de cor: 3000K
Fluxo luminoso: 1850lm



Pendente
Lâmina
BB006G

Material: alumínio
Cor: french gold
Tensão: bivolt
Potência: 1X37W
Soquete: LED
Medida: Ø45cm x9.5cm
Temperatura de cor: 3000K
Fluxo luminoso: 1850lm



Pendente
Lâmina
BB007E

Material: alumínio
Cor: rose gold
Tensão: bivolt
Potência: 1X50W
Soquete: LED
Medida: Ø60cm x9.5cm
Temperatura de cor: 3000K
Fluxo luminoso: 2500lm



Aura Piccola



Pendente

Aura Piccola

IDO10E

Material: metal e cristal
Cor: cobre e champagne
Tensão: bivolt
Potência: 1X24W
Soquete: LED
Medida: Ø60cm x5.5cm
Temperatura de cor: 3000K
Fluxo luminoso: 1320lm



Pendente

Aura Piccola

IDO10C

Material: metal e cristal
Cor: cromado e transparente
Tensão: bivolt
Potência: 1X24W
Soquete: LED
Medida: Ø60cm x5.5cm
Temperatura de cor: 3000K
Fluxo luminoso: 1320lm



Media Luna

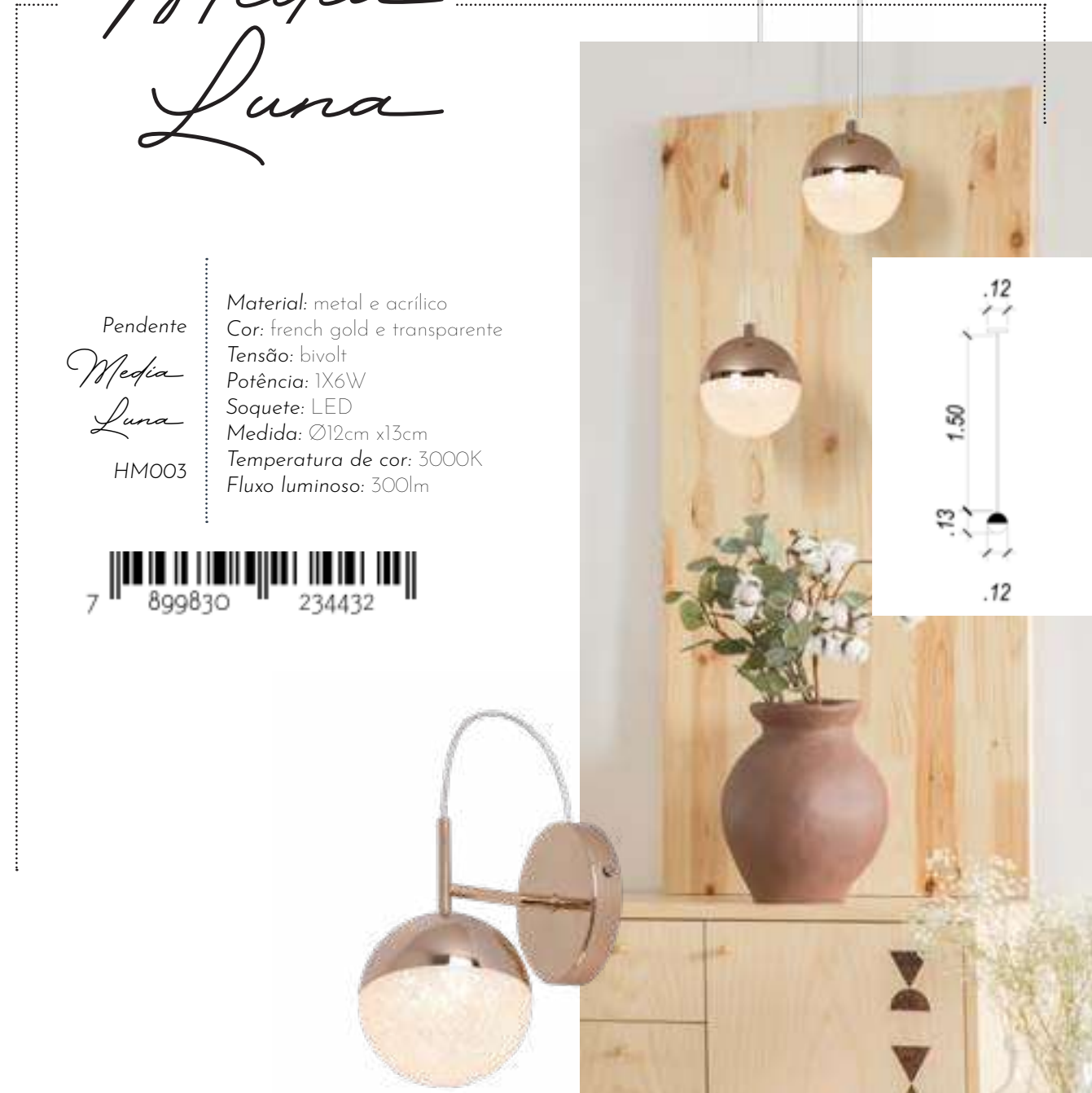

Pendente

Media Luna

HM003

Material: metal e acrílico
Cor: french gold e transparente
Tensão: bivolt
Potência: 1X6W
Soquete: LED
Medida: Ø12cm x13cm
Temperatura de cor: 3000K
Fluxo luminoso: 300lm



Arandela

Media Luna

HM004

Material: metal e acrílico
Cor: french gold e transparente
Tensão: bivolt
Potência: 1X6W
Soquete: LED
Medida: 12cm x 18cm x27.5cm
Temperatura de cor: 3000K
Fluxo luminoso: 300lm

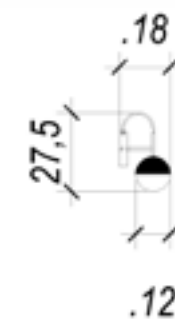



Manacá

Pendente
Manacá
BD003M

Material: metal e acrílico
Cor: dourado e branco
Tensão: bivolt
Potência: 34X3W (102W)
Soquete: LED
Medida: Ø92cm
Temperatura de cor: 3000K
Fluxo luminoso: 6120lm

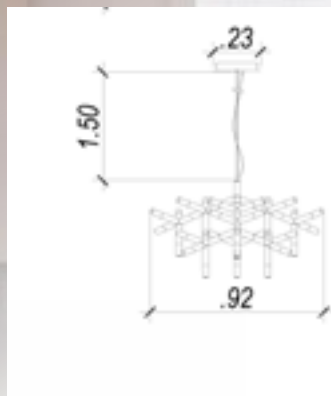

Arandela
Manacá
BD004

Material: metal e acrílico
Cor: dourado e branco
Tensão: bivolt
Potência: 4X3W (12W)
Soquete: LED
Medida: 7cm x 12cm x 47cm
Temperatura de cor: 3000K
Fluxo luminoso: 720lm

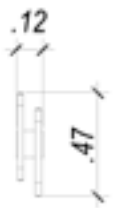

Plafon
Manacá
BD001S

Material: metal e acrílico
Cor: dourado preto e branco
Tensão: bivolt
Potência: 16W + 8W (39W)
Soquete: LED
Medida: Ø47.5cm x 30.5cm
Temperatura de cor: 3000K
Fluxo luminoso: 2160lm



Plafon
Manacá
BD001M

Material: metal e acrílico
Cor: dourado preto e branco
Tensão: bivolt
Potência: 16W + 8W (48W)
Soquete: LED
Medida: Ø62cm x 30.5cm
Temperatura de cor: 3000K
Fluxo luminoso: 2880lm



Pendente
Manacá
BD003S

Material: metal e acrílico
Cor: dourado e branco
Tensão: bivolt
Potência: 25X3W (75W)
Soquete: LED
Medida: Ø72cm
Temperatura de cor: 3000K
Fluxo luminoso: 4500lm

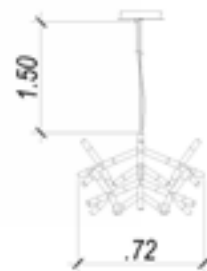
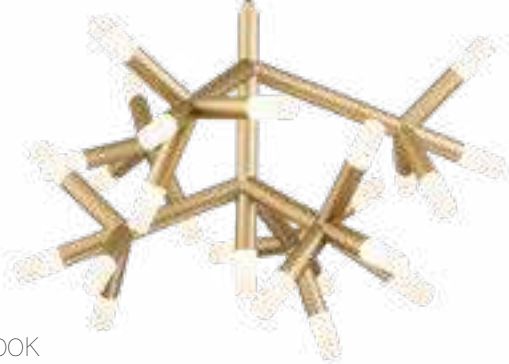

Ninho

Pendente
Ninho
WD017L

Material: metal e silicone
Cor: rose gold
Tensão: bivolt
Potência: 1X36W
Soquete: LED
Medida: Ø62cm
Temperatura de cor: 3000K
Fluxo luminoso: 2880lm

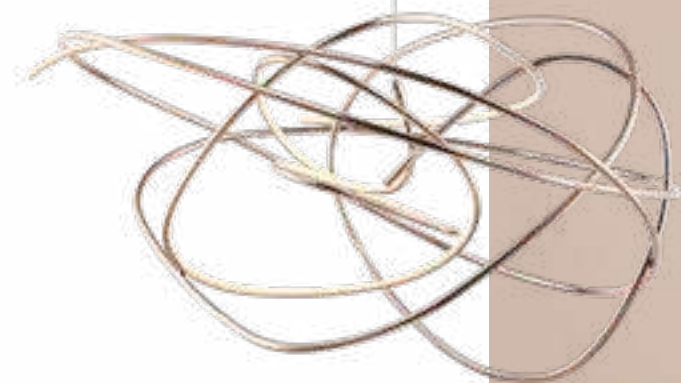

Pendente
Ninho
WD017M

Material: metal e silicone
Cor: rose gold
Tensão: bivolt
Potência: 1X24W
Soquete: LED
Medida: Ø41cm
Temperatura de cor: 3000K
Fluxo luminoso: 1920lm



Pendente
Ninho
WD017S

Material: metal e silicone
Cor: rose gold
Tensão: bivolt
Potência: 1X12W
Soquete: LED
Medida: Ø23cm
Temperatura de cor: 3000K
Fluxo luminoso: 960lm

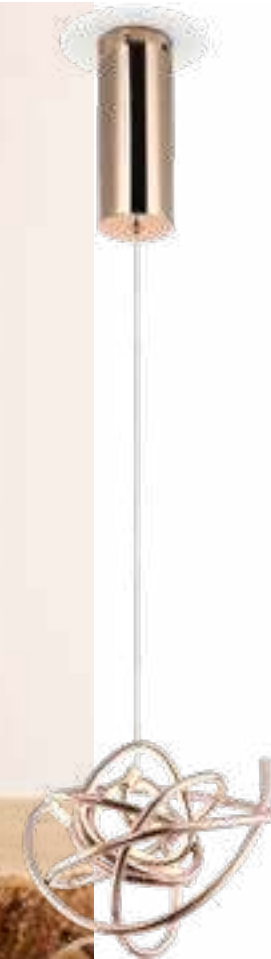

Arandela
Ninho
WD018

Material: metal e silicone
Cor: rose gold
Tensão: bivolt
Potência: 1X12W
Soquete: LED
Medida: Ø23cm
Temperatura de cor: 3000K
Fluxo luminoso: 960lm



Mimo



Pendente
Mimo
BB004E

Material: metal acrílico e vidro
Cor: rose gold e transparente
Tensão: bivolt
Potência: 1X5W
Soquete: LED
Medida: Ø16cm x 36cm
Temperatura de cor: 3000K
Fluxo luminoso: 500lm



Pendente
Mimo
BB004G

Material: metal acrílico e vidro
Cor: french gold e transparente
Tensão: bivolt
Potência: 1X5W
Soquete: LED
Medida: Ø16cm x 36cm
Temperatura de cor: 3000K
Fluxo luminoso: 500lm



Occhio



Pendente
Occhio
JJ014

Material: metal e acrílico
Cor: dourado preto e branco
Tensão: bivolt
Potência: 16X3W (48W)
Soquete: LED
Medida: Ø65cm x 4cm x 4cm x 10cm
Temperatura de cor: 3000K
Fluxo luminoso: 3360lm



Arandela
Occhio
JJ015

Material: metal e acrílico
Cor: dourado preto e branco
Tensão: bivolt
Potência: 1X3W
Soquete: LED
Medida: Ø12cm x 8.5cm
Temperatura de cor: 3000K
Fluxo luminoso: 210lm





Zig

Pendente
Zig
TPO01

Material: metal
Cor: branco
Tensão: bivolt
Potência: 1X70W
Soquete: LED
Medida: 47cm x 57cm x 26cm
Temperatura de cor: 3000K
Fluxo luminoso: 3500lm



Pendente
Zig
TPO02

Material: metal
Cor: branco
Tensão: bivolt
Potência: 1X52W
Soquete: LED
Medida: 32cm x 88cm x 22cm
Temperatura de cor: 3000K
Fluxo luminoso: 2600lm



Pendente
Zig
TPO03

Material: metal
Cor: branco
Tensão: bivolt
Potência: 1X76W
Soquete: LED
Medida: 22cm x 84cm x 21cm
Temperatura de cor: 3000K
Fluxo luminoso: 3800lm



Coluna
Zig
SB004

Material: metal
Cor: branco
Tensão: bivolt
Potência: 1X30W
Soquete: LED
Medida: Ø23cm x 115cm
Temperatura de cor: 3000K
Fluxo luminoso: 3300lm



Onda



Pendente

Onda

OC008L

Material: metal e acrílico
Cor: dourado e transparente
Tensão: bivolt
Potência: 4X2,5W(10W)
Soquete: LED
Medida: Ø40cm x2cm
Temperatura de cor: 3000K
Fluxo luminoso: 500lm



Pendente

Onda

OC008S

Material: metal e acrílico
Cor: dourado e transparente
Tensão: bivolt
Potência: 1X2,5W
Soquete: LED
Medida: 7cm x 14.8cm x22cm
Temperatura de cor: 3000K
Fluxo luminoso: 125lm



Orbit



Pendente

Orbit

ID009C

Material: metal e cristal
Cor: cromado e transparente
Tensão: bivolt
Potência: 1X30W
Soquete: LED
Medida: Ø62cm x3.5cm
Temperatura de cor: 3000K
Fluxo luminoso: 1650lm



Pendente

Orbit

ID009E

Material: metal e cristal
Cor: rose gold e champagne
Tensão: bivolt
Potência: 1X30W
Soquete: LED
Medida: Ø62cm x3.5cm
Temperatura de cor: 3000K
Fluxo luminoso: 1650lm



Skay

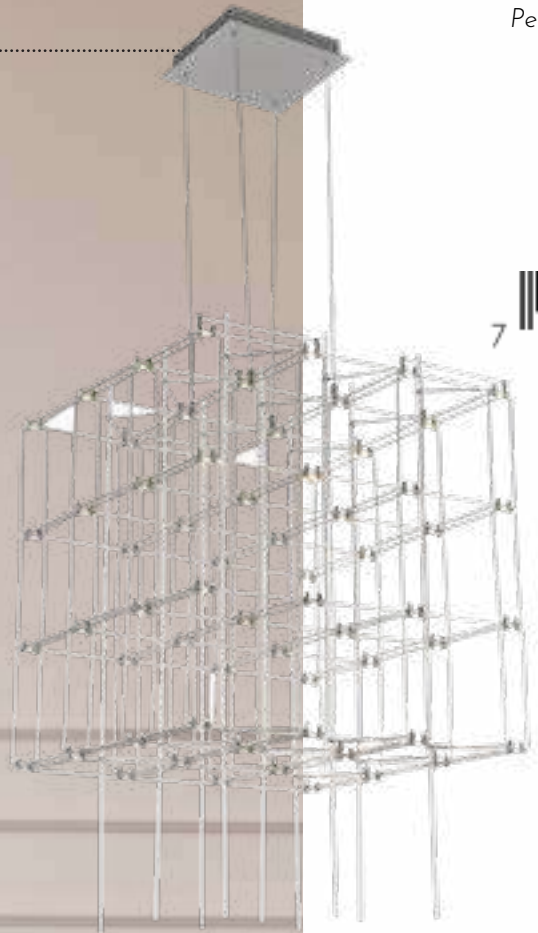

Pendente

Skay

JJ007

Material: metal e acrílico
Cor: cromado e transparente
Tensão: bivolt
Potência: 64X0,2W(12,8W)
Soquete: LED
Medida: 55cm x 58cm x 58cm
Temperatura de cor: 3000K
Fluxo luminoso: 1024lm



Pendente

Skay

JJ008

Material: metal e acrílico
Cor: cromado e transparente
Tensão: bivolt
Potência: 54X0,2W(10,8W)
Soquete: LED
Medida: 41cm x 91cm x 40cm
Temperatura de cor: 3000K
Fluxo luminoso: 864lm



Tino



Plafon

Tino

CD007

Material: aço e alumínio
Cor: sand gold e branco
Tensão: bivolt
Potência: 1X12W
Soquete: LED
Medida: Ø30cm x 60cm
Temperatura de cor: 2700K
Fluxo luminoso: 600lm

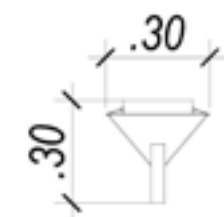



Tom

Pendente
Tom
LR001
Material: metal
Cor: dourado
Tensão: bivolt
Potência: 1X38W
Soquete: LED
Medida: 106cm x 21cm x 26cm
Temperatura de cor: 3000K
Fluxo luminoso: 1900lm



Arandela
Tom
LR002
Material: metal
Cor: dourado
Tensão: bivolt
Potência: 1X20W
Soquete: LED
Medida: 26cm x 26cm x 12cm
Temperatura de cor: 3000K
Fluxo luminoso: 600lm

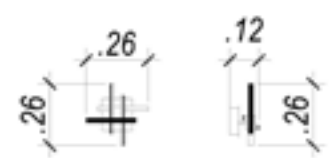

Tru



Pendente
Tru
HC004
Material: metal e vidro
Cor: dourado e branco
Tensão: bivolt
Potência: 1X21W
Soquete: LED
Medida: Ø24cm x 36.5cm
Temperatura de cor: 3000K
Fluxo luminoso: 1050lm



Pendente
Tru
HC005
Material: metal e vidro
Cor: dourado e branco
Tensão: bivolt
Potência: 1X30W
Soquete: LED
Medida: Ø24cm x 45.5cm
Temperatura de cor: 3000K
Fluxo luminoso: 1500lm

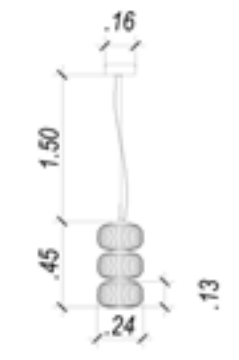



Tsuki

Pendente
Tsuki
BB009L

Material: metal e acrílico
Cor: bronze e transparente
Tensão: bivolt
Potência: 40X1,5W (60W)
Soquete: LED
Medida: Ø97cm x48cm
Temperatura de cor: 3000K
Fluxo luminoso: 6000lm



Veu

Pendente
Veu
HO300

Material: metal e cristal
Cor: rose gold e transparente
Tensão: bivolt
Potência: 1X15W
Soquete: LED
Medida: 5cm x 85.8cm x13.4cm
Temperatura de cor: 3000K
Fluxo luminoso: 1200lm



Arandela
Veu
HO301

Material: metal e cristal
Cor: rose gold e transparente
Tensão: bivolt
Potência: 1X5,4W
Soquete: LED
Medida: 19cm x 7cm x13cm
Temperatura de cor: 3000K
Fluxo luminoso: 432lm





Vita

Pendente
Vita
HM005S

Material: metal e cristal de rocha
Cor: bronze e transparente
Tensão: bivolt
Potência: 1X4W
Soquete: LED
Medida: Ø3,2cm x51cm
Temperatura de cor: 3000K
Fluxo luminoso: 200lm



Pendente
Vita
HM005L

Material: metal e cristal de rocha
Cor: bronze e transparente
Tensão: bivolt
Potência: 9X4W (36W)
Soquete: LED
Medida: Ø38cm x51cm
Temperatura de cor: 3000K
Fluxo luminoso: 1800lm

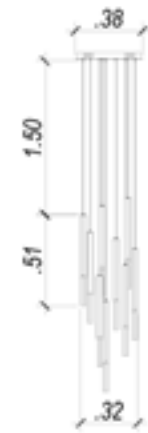

Pendente
Vita
HM005M

Material: metal e cristal de rocha
Cor: bronze e transparente
Tensão: bivolt
Potência: 5X4W (20W)
Soquete: LED
Medida: Ø28cm x51cm
Temperatura de cor: 3000K
Fluxo luminoso: 1000lm

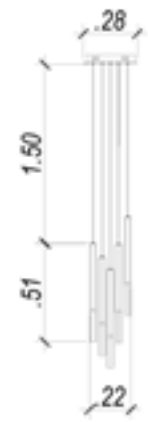

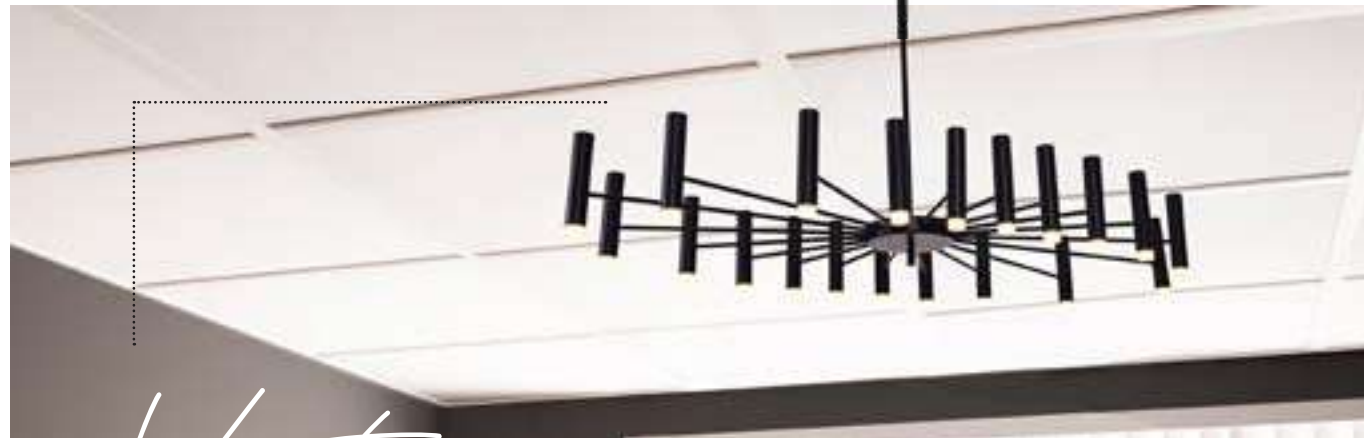

Vinte

Pendente

Vinte

JJ013B

Material: metal e acrílico
Cor: preto
Tensão: bivolt
Potência: 20X3W(60W)
Soquete: LED
Medida: Ø120cm x 60cm x 60cm x 15cm
Temperatura de cor: 3000K
Fluxo luminoso: 4200lm



Pendente

Vinte

JJ013G

Material: metal e acrílico
Cor: dourado
Tensão: bivolt
Potência: 20X3W(60W)
Soquete: LED
Medida: Ø120cm x 60cm x 60cm x 15cm
Temperatura de cor: 3000K
Fluxo luminoso: 4200lm



Voile

Arandela

Voile

BB017

Material: aço e alumínio
Cor: rose gold
Tensão: bivolt
Potência: 1X8W
Soquete: LED
Medida: 8cm x 32cm x 26cm
Temperatura de cor: 3000K
Fluxo luminoso: 400lm

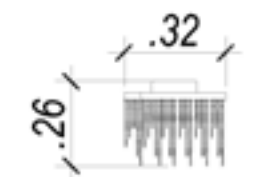

Pendente

Voile

BB003

Material: aço e alumínio
Cor: rose gold
Tensão: bivolt
Potência: 1X33,6W
Soquete: LED
Medida: Ø120cm x 18cm
Temperatura de cor: 3000K
Fluxo luminoso: 1680lm





LUSTRE
Anjou
JF015A
Material: metal e vidro
Cor: cromado e champagne
Tensão: bivolt
Potência: 5X40W (200W)
Soquete: E14
Medida: Ø58cmx63cm



LUSTRE
Anjou
JF018A
Material: metal e vidro
Cor: cromado e champagne
Tensão: bivolt
Potência: 8X40W (320W)
Soquete: E14
Medida: Ø68cmx68cm



LUSTRE
Anjou
JF112A
Material: metal e vidro
Cor: cromado e champagne
Tensão: bivolt
Potência: 12X40W (480W)
Soquete: E14
Medida: Ø82cmx79cm



LUSTRE
Anjou
JF118A
Material: metal e vidro
Cor: cromado e champagne
Tensão: bivolt
Potência: 18X40W (720W)
Soquete: E14
Medida: Ø82cmx100cm



LUSTRE
Anjou
JF028S
Material: metal e vidro
Cor: cromado e fume
Tensão: bivolt
Potência: 8X40W (320W)
Soquete: E14
Medida: Ø66cmx58cm





LUSTRE

Anjou

JF015C

Material: metal e vidro
Cor: cromado e transp
Tensão: bivolt
Potência: 5X40W (200W)
Soquete: E14
Medida: Ø58cmx635cm



LUSTRE

Anjou

JF018C

Material: metal e vidro
Cor: cromado e transp
Tensão: bivolt
Potência: 8X40W (320W)
Soquete: E14
Medida: Ø68cmx68cm



LUSTRE

Anjou

JF112C

Material: metal e vidro
Cor: cromado e transp
Tensão: bivolt
Potência: 12X40W (480W)
Soquete: E14
Medida: Ø82cmx79cm



LUSTRE

Anjou

JF118C

Material: metal e vidro
Cor: cromado e transp
Tensão: bivolt
Potência: 18X40W (720W)
Soquete: E14
Medida: Ø82cmx100cm



BELLA
15 anos iluminando

Elysée



LUSTRE

Elysée

BK5308

Material: metal cristal e vidro
Cor: dourado e transp
Tensão: bivolt
Potência: 8X40W (320W)
Soquete: E14
Medida: Ø72cmx78cm



LUSTRE

Elysée

BK5318

Material: metal cristal e vidro
Cor: dourado e transp
Tensão: bivolt
Potência: 18X40W (720W)
Soquete: E14
Medida: Ø120cmx145cm



Gallery



LUSTRE
Gallery
BW1308B

Material: metal cristal e vidro
Cor: cromado e preto
Tensão: bivolt
Potência: 8X40W (320W)
Soquete: E14
Medida: Ø85cmx96cm



Passy



LUSTRE
Passy
AQ028S

Material: metal cristal e vidro
Cor: bronze e conhaque e transp
Tensão: bivolt
Potência: 6X40W (240W)
Soquete: E14
Medida: Ø45cmx50cm



LUSTRE
Gallery
BW1308C

Material: metal cristal e vidro
Cor: cromado e transp
Tensão: bivolt
Potência: 8X40W (320W)
Soquete: E14
Medida: Ø85cmx96cm



LUSTRE
Passy
AQ028L

Material: metal cristal e vidro
Cor: bronze e conhaque e transp
Tensão: bivolt
Potência: 12X40W (480W)
Soquete: E14
Medida: Ø65cmx70cm



Tyene



PENDENTE

Tyene

JF305

Material: metal e vidro
Cor: rose gold e transp
Tensão: bivolt
Potência: 5X40W (200W)
Soquete: E14
Medida: Ø54cmx63cm



PENDENTE

Tyene

JF308

Material: metal e vidro
Cor: rose gold e transp
Tensão: bivolt
Potência: 8X40W (320W)
Soquete: E14
Medida: Ø72cmx64cm



PENDENTE

Tyene

JF312

Material: metal e vidro
Cor: rose gold e transp
Tensão: bivolt
Potência: 12X40W (480W)
Soquete: E14
Medida: Ø65cmx75cm



Paris



LUSTRE

Paris

AQ024S

Material: metal e cristal
Cor: dourado e transp
Tensão: bivolt
Potência: 11X40W (440W)
Soquete: E14
Medida: Ø65cmx65cm



LUSTRE

Paris

AQ024L

Material: metal e cristal
Cor: dourado e transp
Tensão: bivolt
Potência: 17X40W (680W)
Soquete: E14
Medida: Ø85cmx89cm



Odeon

LUSTRE

Odeon

AQ026L

Material: metal e vidro
Cor: dourado e conhaque
Tensão: bivolt
Potência: 16X40W (640W)
Soquete: E14
Medida: Ø78cmx48cm



Foglia



PENDENTE

Foglia

OC003

Material: metal e cristal
Cor: san@ol@e transp
Tens@o: bivolt
Pot@ncia: 16X40W (640W)
Soquete: E14
Medida: Ø60cmx38cm



Palace



LUSTRE

Palace

AQ025M

Material: metal e cristal
Cor: cromado e transp
Tens@o: bivolt
Pot@ncia: 15X40W (600W)
Soquete: E14
Medida: Ø68cmx54cm



Vivi



PENDENTE

Vivi

AQ031C

Material: metal e cristal
Cor: cromado e transp
Tens@o: bivolt
Pot@ncia: 9X40W (360W)
Soquete: E14
Medida: Ø60cmx42cm



PENDENTE

Vivi

AQ031G

Material: metal e cristal
Cor: french gol@e conhaque
Tens@o: bivolt
Pot@ncia: 9X40W (360W)
Soquete: E14
Medida: Ø60cmx42cm



Hera



PENDENTE

Hera

AQ030C

Material: metal e cristal
Cor: cromado e conhaque
Tens@o: bivolt
Pot@ncia: 10X40W (400W)
Soquete: E14
Medida: Ø48cmx49cm



PENDENTE

Hera

AQ030G

Material: metal e cristal
Cor: french gol@e transp
Tens@o: bivolt
Pot@ncia: 10X40W (400W)
Soquete: E14
Medida: Ø48cmx49cm



Kri



PENDENTE

Kri

HU2105

Material: metal e cristal
Cor: cromado e transp
Tensão: bivolt
Potência: 1X40W
Soquete: G9
Medida: Ø18cmx21cm



PENDENTE

Kri

HU2105A

Material: metal e cristal
Cor: cromado e ambar
Tensão: bivolt
Potência: 1X40W
Soquete: G9
Medida: Ø18cmx21cm



PLAFON

Kri

HU1103

Material: metal e vidro
Cor: cromado e transp
Tensão: bivolt
Potência: 5X40W (200W)
Soquete: G9
Medida: Ø40cmx24cm



PLAFON

Kri

HU1104

Material: metal e vidro
Cor: cromado e transp
Tensão: bivolt
Potência: 9X40W (360W)
Soquete: G9
Medida: Ø54cmx26cm



PLAFON

Kri

HU1103A

Material: metal e vidro
Cor: cromado e ambar
Tensão: bivolt
Potência: 5X40W (200W)
Soquete: G9
Medida: Ø40cmx24cm



PLAFON

Kri

HU1104A

Material: metal e vidro
Cor: cromado e ambar
Tensão: bivolt
Potência: 9X40W (360W)
Soquete: G9
Medida: Ø54cmx26cm





PLAFON
Kri
HU1100
Material: metal e cristal
Cor: cromado e transp
Tensão: bivolt
Potência: 4X40W (160W)
Soquete: G9
Medida: Ø27cmx19.5cm



PLAFON
Kri
HU1100A
Material: metal e cristal
Cor: cromado e ambar
Tensão: bivolt
Potência: 4X40W (160W)
Soquete: G9
Medida: Ø27cmx19.5cm



PLAFON
Kri
HU1101
Material: metal e cristal
Cor: cromado e transp
Tensão: bivolt
Potência: 4X40W (160W)
Soquete: G9
Medida: Ø27cmx24cm



PLAFON
Kri
HU1101A
Material: metal e cristal
Cor: cromado e ambar
Tensão: bivolt
Potência: 4X40W (160W)
Soquete: G9
Medida: Ø27cmx13cm



PLAFON
Kri
HU1102
Material: metal e cristal
Cor: cromado e transp
Tensão: bivolt
Potência: 4X40W (160W)
Soquete: G9
Medida: Ø25cmx20cm



PLAFON
Kri
HU1102A
Material: metal e cristal
Cor: cromado e ambar
Tensão: bivolt
Potência: 4X40W (160W)
Soquete: G9
Medida: Ø25cmx20cm



Charm



PENDENTE
Charm
HU2157
Material: metal e cristal
Cor: cromado e transp
Tensão: bivolt
Potência: 13X40W (520W)
Soquete: G9
Medida: 59cmx59cmx26cm



PENDENTE
Charm
HU2157A
Material: metal e cristal
Cor: cromado e ambar
Tensão: bivolt
Potência: 13X40W (520W)
Soquete: G9
Medida: 59cmx59cmx26cm



PENDENTE
Charm
HU2161
Material: metal e cristal
Cor: cromado e transp
Tensão: bivolt
Potência: 11X40W (440W)
Soquete: G9
Medida: 32cmx80cmx26cm



PENDENTE
Charm
HU2161A
Material: metal e cristal
Cor: cromado e ambar
Tensão: bivolt
Potência: 11X40W (440W)
Soquete: G9
Medida: 32cmx80cmx26cm





Dijon



LUSTRE
Dijon
AQ008L

Material: metal e cristal
Cor: cromado e transp
Tensão: bivolt
Potência: 13X40W (520W)
Soquete: E14
Medida: Ø80cmx38cm



PLAFON
Dijon
AQ008LA

Material: metal e cristal
Cor: cromado e ambar
Tensão: bivolt
Potência: 13X40W (520W)
Soquete: E14
Medida: Ø80cmx38cm



LUSTRE
Dijon
AQ009

Material: metal e cristal
Cor: cromado e transp
Tensão: bivolt
Potência: 12X40W (480W)
Soquete: E14
Medida: Ø70cmx60cm



LUSTRE
Dijon
AQ009A

Material: metal e cristal
Cor: cromado e ambar
Tensão: bivolt
Potência: 15X40W (480W)
Soquete: E14
Medida: Ø70cmx60cm



LUSTRE
Dijon
AQ009M

Material: metal e cristal
Cor: cromado e transp
Tensão: bivolt
Potência: 9X40W (360W)
Soquete: E14
Medida: Ø54cmx50cm



LUSTRE
Dijon
AQ009MA

Material: metal e cristal
Cor: cromado e ambar
Tensão: bivolt
Potência: 9X40W (360W)
Soquete: E14
Medida: Ø54cmx50cm



Fiore



PENDENTE

Fiore

HU2107

Material: metal e cristal
Cor: cromado e transp
Tensão: bivolt
Potência: 1X40W
Soquete: G9
Medida: Ø26cmx24cm



PENDENTE

Fiore

HU2107A

Material: metal e cristal
Cor: cromado e ambar
Tensão: bivolt
Potência: 1X40W
Soquete: G9
Medida: Ø26cmx24cm



PENDENTE

Fiore

HU2106

Material: metal e cristal
Cor: cromado e transp
Tensão: bivolt
Potência: 1X40W
Soquete: G9
Medida: Ø16cmx18cm



PENDENTE

Fiore

HU2106A

Material: metal e cristal
Cor: cromado e ambar
Tensão: bivolt
Potência: 1X40W
Soquete: G9
Medida: Ø16cmx18cm



Nut



PENDENTE

Nut

HU2174A

Material: metal e cristal
Cor: cromado e ambar
Tensão: bivolt
Potência: 5X40W (200W)
Soquete: G9
Medida: Ø40cmx51cm



PENDENTE

Nut

HU2173A

Material: metal e cristal
Cor: cromado e ambar
Tensão: bivolt
Potência: 2X40W (80W)
Soquete: G9
Medida: Ø23cmx28cm



PENDENTE

Nut

HU2173

Material: metal e cristal
Cor: cromado e transp
Tensão: bivolt
Potência: 2X40W (80W)
Soquete: G9
Medida: Ø23cmx28cm



Indian



PENDENTE
Indian
GX008

Material: metal e cristal
Cor: preto e transp
Tensão: bivolt
Potência: 1X40W
Soquete: E27
Medida: Ø34cmx64cm



PENDENTE
Indian
GX008SC

Material: metal e cristal
Cor: dourado e transp
Tensão: bivolt
Potência: 1X40W
Soquete: E27
Medida: Ø23cmx39cm



Arpejo



PENDENTE
Arpejo
GA011

Material: metal e cristal
Cor: cromado e transp
Tensão: bivolt
Potência: 1X40W
Soquete: G9
Medida: Ø11cm



PENDENTE
Goutte
GA014

Material: metal e cristal
Cor: cromado e transp
Tensão: bivolt
Potência: 1X40W
Soquete: G9
Medida: Ø10cmx15cm

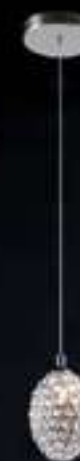

Goutte



Eze



LUSTRE
Eze
AQ004S

Material: metal e cristal
Cor: cromado e transp
Tensão: bivolt
Potência: 5X40W (200W)
Soquete: E14
Medida: 80cmx46cmx50cm





Flora

ARANDELA

Flora

DY002

Material: metal e cristal
Cor: dourado e transp
Tensão: bivolt
Potência: 6X3W (18W)
Soquete: G4
Medida: 23cmx53cmx18cm

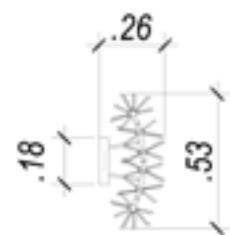

PENDENTE

Flora

DY001S

Material: metal e cristal
Cor: dourado e transp
Tensão: bivolt
Potência: 18X3W (54W)
Soquete: G4
Medida: Ø60cmx18cm

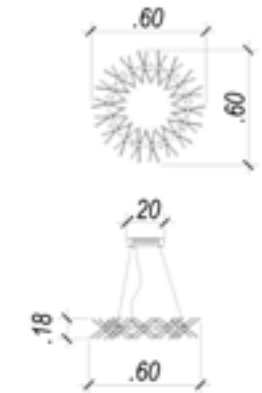

PENDENTE

Flora

DY001L

Material: metal e cristal
Cor: dourado e transp
Tensão: bivolt
Potência: 26X3W (78W)
Soquete: G4
Medida: Ø80cmx18cm

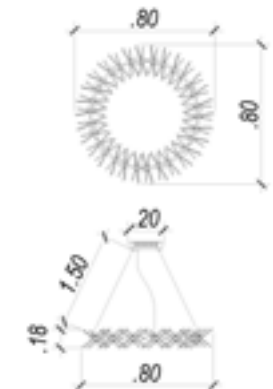

Bells



PENDENTE
Long
OD029C

Material: metal e vidro
Cor: cromado e transp
Tensão: bivolt
Potência: 1X5W
Soquete: LED
Medida: Ø7cmx50cm



PENDENTE
Bells
PDO09S

Material: metal e cristal
Cor: cobre e transp
Tensão: bivolt
Potência: 5X40W (200W)
Soquete: G9
Medida: Ø40cmx16.5cm



PENDENTE
Bells
PDO09L

Material: metal e cristal
Cor: cobre e transp
Tensão: bivolt
Potência: 6X40W (240W)
Soquete: G9
Medida: Ø50cmx19.5cm



PENDENTE
Prism
HU2149P

Material: metal e vidro
Cor: cromado e transp
Tensão: bivolt
Potência: 1X40W
Soquete: G9
Medida: 9cmx9cmx10cm



Prism



Sansa

PENDENTE

Sansa

MRO07

Material: metal e vidro
Cor: dourado e transp
Tensão: bivolt
Potência: 2X40W (80W)
Soquete: E14
Medida: Ø20.5cmx55cm



ARANDELA

Sansa

MRO08

Material: metal e vidro
Cor: dourado e transp
Tensão: bivolt
Potência: 2X40W (80W)
Soquete: E14
Medida: Ø12cmx55cm



Cacau

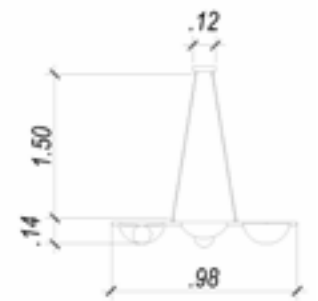

PENDENTE

Cacau

HLO10

Material: metal e vidro
Cor: dourado e branco
Tensão: bivolt
Potência: 3X25W (75W)
Soquete: G9
Medida: 98.5cmx14cmx13cm

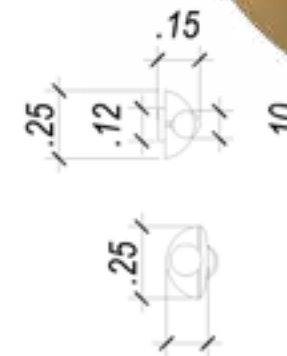
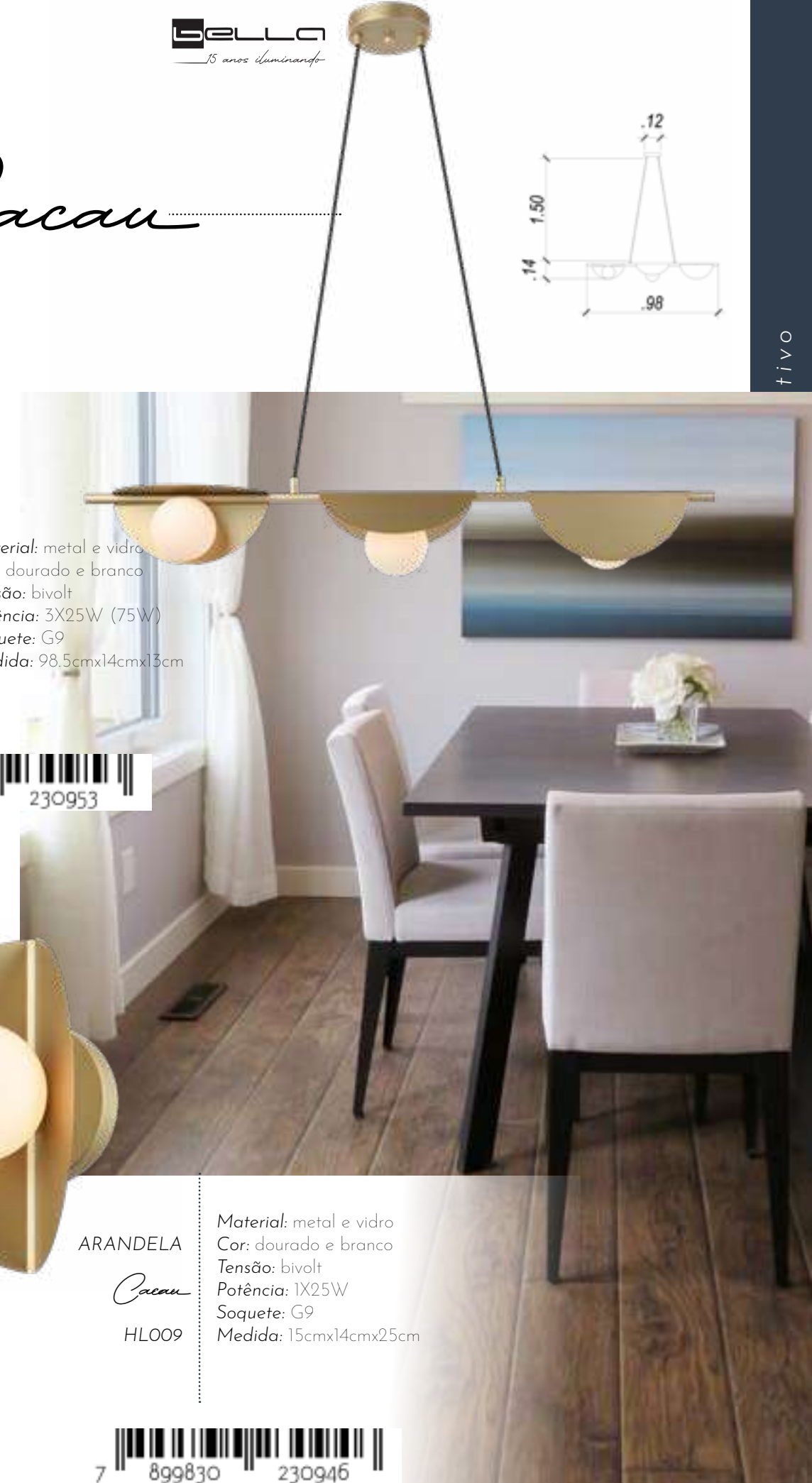

ARANDELA

Cacau

HLO09

Material: metal e vidro
Cor: dourado e branco
Tensão: bivolt
Potência: 1X25W
Soquete: G9
Medida: 15cmx14cmx25cm



Ikira



PENDENTE
Ikira
HLO11M

Material: metal e vidro
Cor: nude e preto e branco
Tensão: bivolt
Potência: 6X25W (150W)
Soquete: G9
Medida: 100cmx22cmx31cm

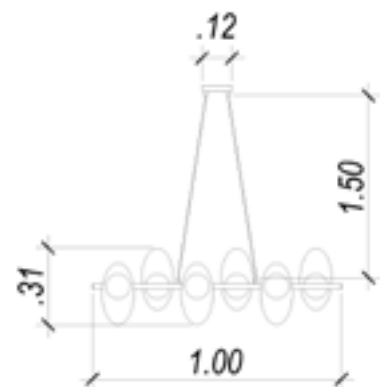

PENDENTE

Ikira

HLO11S

Material: metal e vidro
Cor: nude e preto e branco
Tensão: bivolt
Potência: 4X25W (100W)
Soquete: G9
Medida: 68.5cmx22cmx31cm

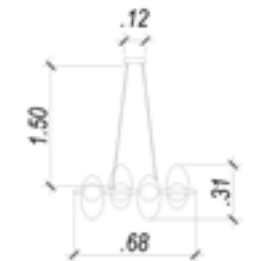

ARANDELA

Ikira

HLO15

Material: metal e vidro
Cor: nude e preto e branco
Tensão: bivolt
Potência: 1X25W
Soquete: G9
Medida: 13cmx14cmx25cm

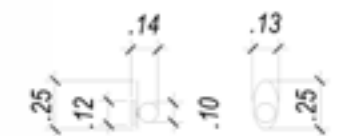

Floresta



PENDENTE

Floresta

HM001

Material: aço alumínio e vidro
Cor: dourado e transp
Tensão: bivolt
Potência: 6X25W (150W)
Soquete: G9
Medida: 40cmx100cmx40cm

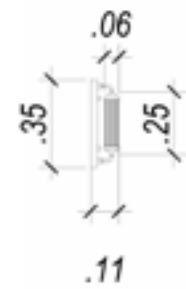
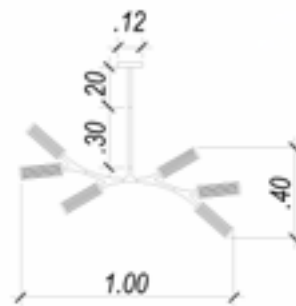

ARANDELA

Floresta

HM002

Material: metal e vidro
Cor: dourado e transp
Tensão: bivolt
Potência: 1X25W
Soquete: G9
Medida: 6cmx11.5cmx35cm



Oscar



PENDENTE

Oscar

HP002

Material: metal e vidro
Cor: dourado e branco
Tensão: bivolt
Potência: 4X25W (100W)
Soquete: G9
Medida: 100cmx12cmx17cm

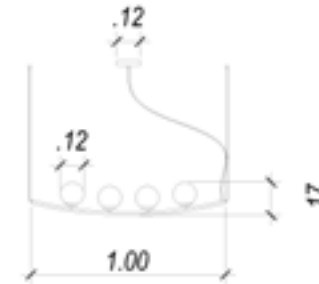

PENDENTE

Oscar

HP001

Material: metal e vidro
Cor: dourado e branco
Tensão: bivolt
Potência: 3X25W (75W)
Soquete: G9
Medida: 108cmx12cmx25cm

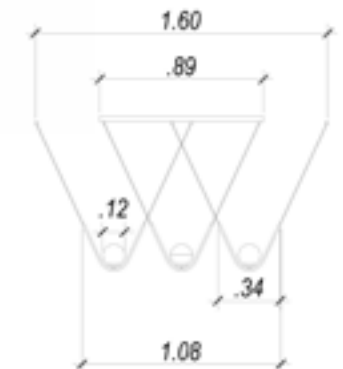

Canela

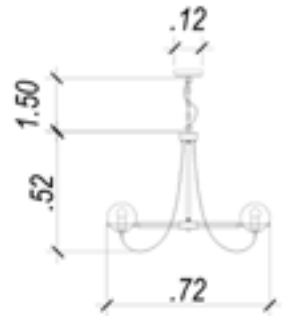

PENDENTE

Canela

DG001

Material: metal e vidro
Cor: dourado preto e transp
Tensão: bivolt
Potência: 7X40W (280W)
Soquete: E14
Medida: Ø72cmx52cm

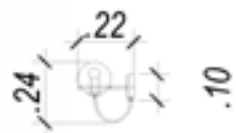

ARANDELA

Canela

DG002

Material: metal e vidro
Cor: dourado preto e transp
Tensão: bivolt
Potência: 1X40W
Soquete: E14
Medida: 19cmx15cmx19cm



Carlota



PENDENTE

Carlota

YD011

Material: metal e vidro
Cor: preto e branco
Tensão: bivolt
Potência: 7X10W (70W)
Soquete: G9
Medida: 113cmx14cmx21.5cm

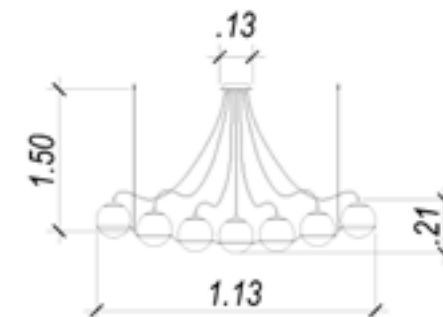

Oxala



PENDENTE

Oxala

RE010S

Material: metal e vidro
Cor: dourado e transp
Tensão: bivolt
Potência: 5X25W (125W)
Soquete: G9
Medida: 49.6cmx62.3cmx31cm

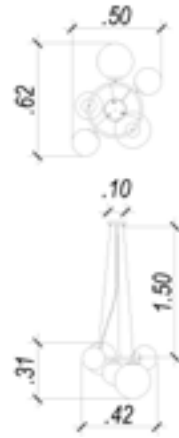

ARANDELA

Oxala

RE011

Material: metal e vidro
Cor: dourado e transp
Tensão: bivolt
Potência: 2X25W (50W)
Soquete: G9
Medida: 26cmx33.5cmx39cm

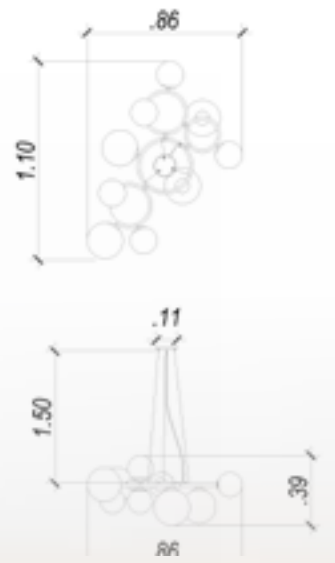
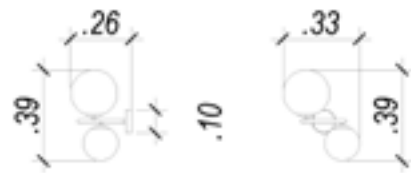

PENDENTE

Oxala

RE010L

Material: metal e vidro
Cor: dourado e transp
Tensão: bivolt
Potência: 9X25W (225W)
Soquete: G9
Medida: 86cmx101cmx39cm



Caiena

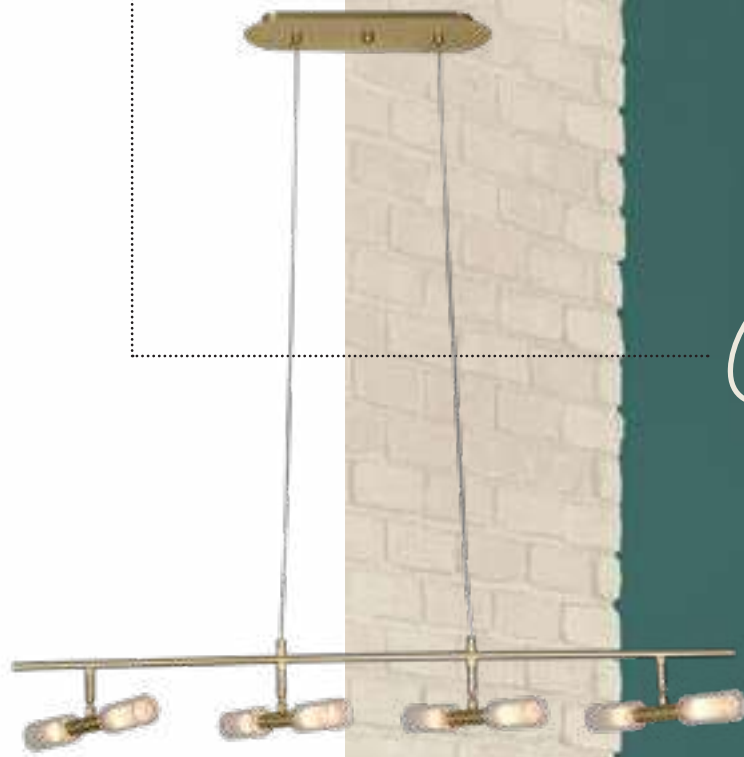

PENDENTE

Caiena

HPO04

Material: metal e vidro
Cor: dourado e branco
Tensão: bivolt
Potência: 8X25W (200W)
Soquete: G9
Medida: 95cmx28cmx12.5cm

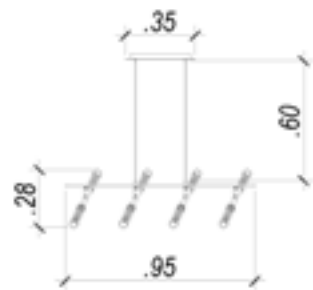

ARANDELA

Caiena

HPO03

Material: metal e vidro
Cor: dourado e branco
Tensão: bivolt
Potência: 2X25W (50W)
Soquete: G9
Medida: 12cmx10cmx28cm

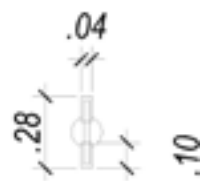

Tahi

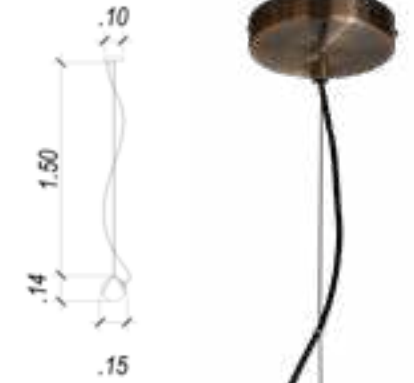

PENDENTE

Tahi

RE014S

Material: metal e vidro
Cor: dourado e transp
Tensão: bivolt
Potência: 1X25W
Soquete: G9
Medida: Ø14cmx15cm



PENDENTE

Tahi

RE014L

Material: metal e vidro
Cor: dourado e transp
Tensão: bivolt
Potência: 3X25W (75W)
Soquete: G9
Medida: Ø38cmx15cm



Vinha

PENDENTE

Vinha

QT001G

Material: metal e vidro
Cor: dourado e conhaque
Tensão: bivolt
Potência: 14X7W (98W)
Soquete: G9
Medida: Ø45cmx45cm

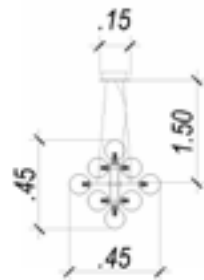

PENDENTE

Vinha

QT001E

Material: metal e vidro
Cor: cobre e transp
Tensão: bivolt
Potência: 14X7W (98W)
Soquete: G9
Medida: Ø45cmx45cm

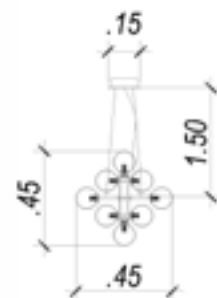

Nix



PENDENTE

Nix

BO013S

Material: metal e vidro
Cor: bronze e transp
Tensão: bivolt
Potência: 6X40W (240W)
Soquete: E14
Medida: Ø66cmx38cm



PENDENTE

Nix

BO013L

Material: metal e vidro
Cor: bronze e transp
Tensão: bivolt
Potência: 10X40W (400W)
Soquete: E14
Medida: Ø99cmx56cm



Malagueta

PENDENTE

Malagueta

GR001

Material: metal e vidro
Cor: dourado e branco
Tensão: bivolt
Potência: 8X10W (80W)
Soquete: G9
Medida: Ø93cmx100cm

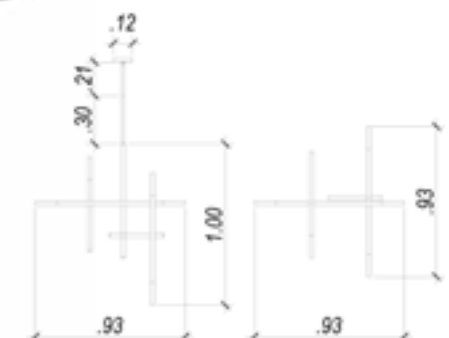

Samba



PENDENTE

Samba

HLO12M

Material: metal e vidro
Cor: dourado e branco
Tensão: bivolt
Potência: 6X25W (150W)
Soquete: G9
Medida: Ø60cmx22cm

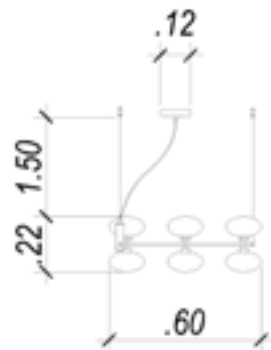

ARANDELA

Samba

HLO13

Material: metal e vidro
Cor: dourado e branco
Tensão: bivolt
Potência: 1X25W
Soquete: G9
Medida: 18.5cmx14cmx20cm

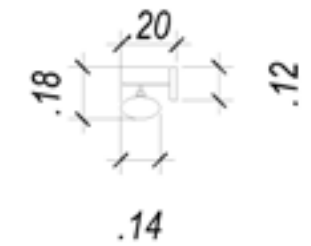

PENDENTE

Samba

HLO12S

Material: metal e vidro
Cor: dourado e branco
Tensão: bivolt
Potência: 4X25W (100W)
Soquete: G9
Medida: Ø41.5cmx22cm

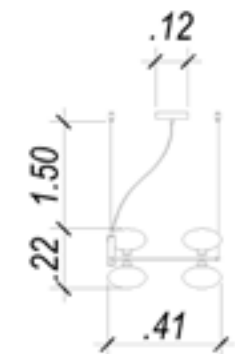

Lamparina

PENDENTE

Lamparina

HC013

Material: metal e vidro
Cor: dourado e transp
Tensão: bivolt
Potência: 1X40W
Soquete: E27
Medida: 20.3cmx31.5cmx20.3cm



ARANDELA

Lamparina

HC012

Material: metal e vidro
Cor: dourado e transp
Tensão: bivolt
Potência: 1X40W
Soquete: E27
Medida: 27.5cmx20.3cmx29.5cm

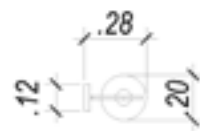

Nero

PENDENTE

Nero

MM002

Material: metal e vidro
Cor: cromo negro e branco
Tensão: bivolt
Potência: 5X10W (50W)
Soquete: G9
Medida: 33cmx62cmx66.2cm

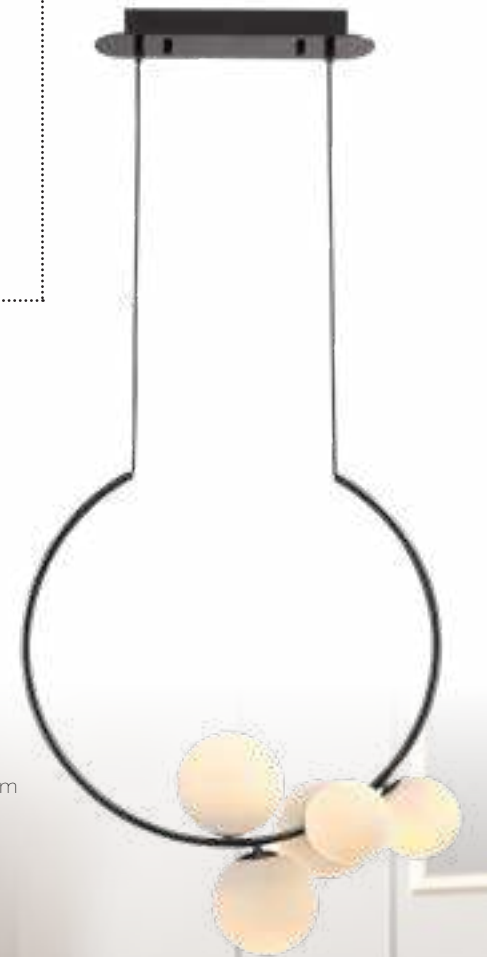
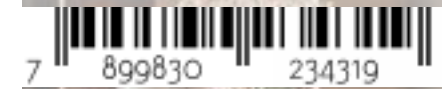

PLAFON

Nero

MM001

Material: metal e vidro
Cor: cromo negro e branco
Tensão: bivolt
Potência: 5X10W (50W)
Soquete: G9
Medida: 33cmx49cmx53cm

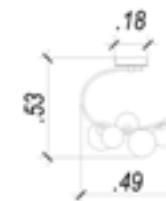

Mob

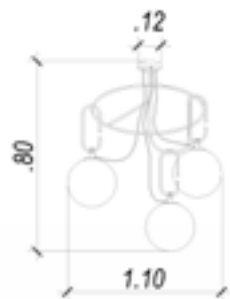

PLAFON
Mob
YD012
Material: metal e vidro
Cor: dourado preto e branco
Tensão: bivolt
Potência: 3X7W (21W)
Soquete: E14
Medida: Ø80cmx110cm



ARANDELA
Mob
YD004
Material: metal e vidro
Cor: dourado preto e branco
Tensão: bivolt
Potência: 1X7W
Soquete: E14
Medida: 48cmx20cmx12cm



PENDENTE
Mob
YD001
Material: metal e vidro
Cor: dourado preto e branco
Tensão: bivolt
Potência: 1X7W
Soquete: E14
Medida: Ø20cmx48cm



PENDENTE
Mob
YD005
Material: metal e vidro
Cor: dourado preto e branco
Tensão: bivolt
Potência: 1X7W
Soquete: E14
Medida: Ø20cmx80cmx48cm



PENDENTE
Mob
YD003
Material: metal e vidro
Cor: dourado preto e branco
Tensão: bivolt
Potência: 3X7W (21W)
Soquete: E14
Medida: Ø130cmx85cm



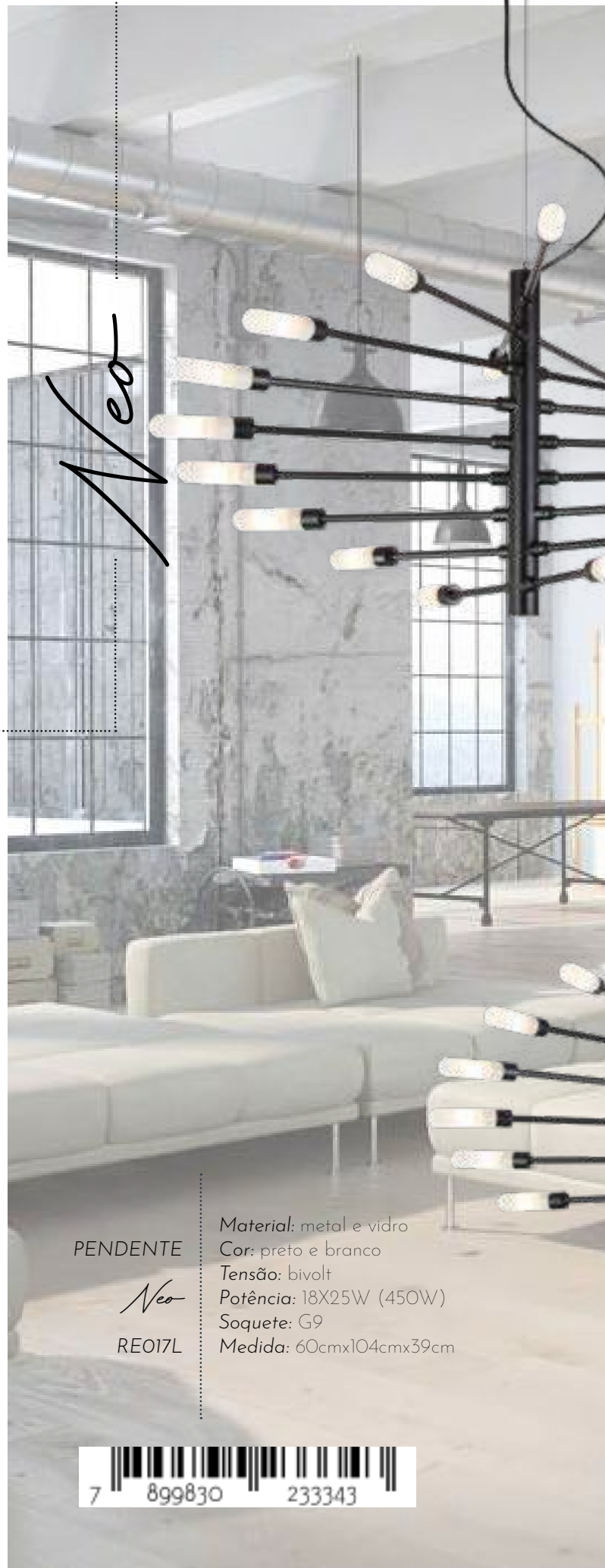

Neo

PENDENTE

Neo

RE017S

Material: metal e vidro
Cor: preto e branco
Tensão: bivolt
Potência: 12X25W(300W)
Soquete: G9
Medida: 60cmx86cmx32cm

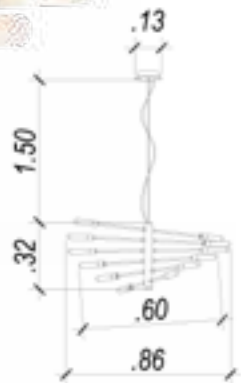

PENDENTE

Neo

RE017L

Material: metal e vidro
Cor: preto e branco
Tensão: bivolt
Potência: 18X25W (450W)
Soquete: G9
Medida: 60cmx104cmx39cm



Mobile

PENDENTE

Mobile

BB014

Material: metal e vidro
Cor: dourado e champagne
Tensão: bivolt
Potência: 6 x 13W(78W)
Soquete: E14
Medida: Ø65cm

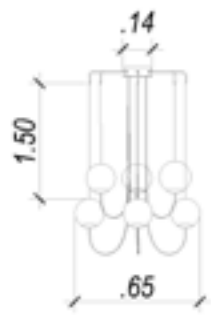

Mol



PENDENTE

Mol

OD040

Material: metal e vidro
Cor: san@gol@e champagne
Tensão: bivolt
Potência: 9X25W (225W)
Soquete: G9
Medida: Ø60cmx30cmx30cmx40cm



Guaraná

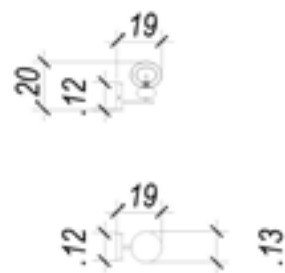

ARANDELA
Guarana
HC006

Material: metal e vidro
Cor: bronze e preto e transp
Tensão: bivolt
Potência: 1X5W
Soquete: G9
Medida: 20,8cmx13,4cmx19,5cm

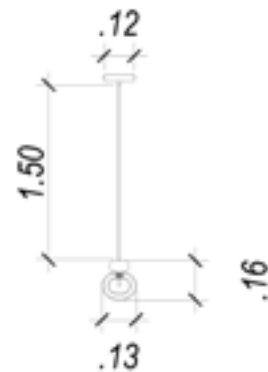

PENDENTE
Guarana
HC007S

Material: metal e vidro
Cor: bronze e preto e transp
Tensão: bivolt
Potência: 1X5W
Soquete: G9
Medida: Ø13,4cmx15,6cm

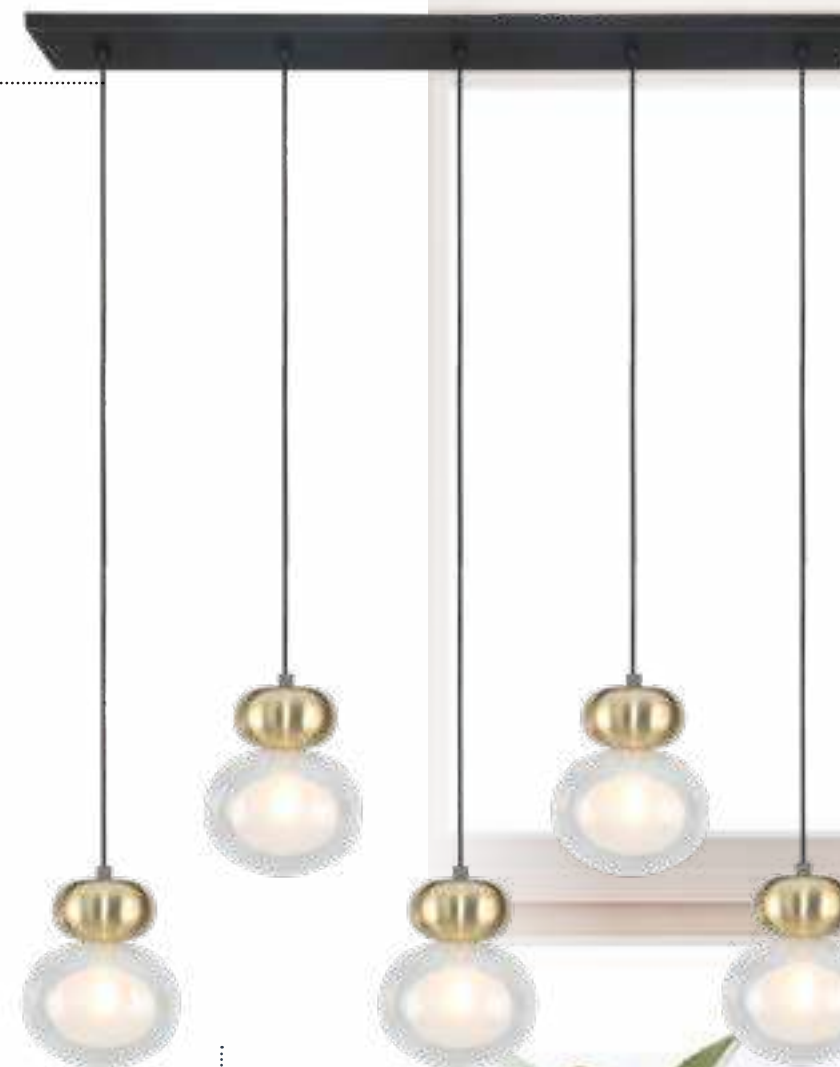

PENDENTE
Guarana
HC007L

Material: metal e vidro
Cor: bronze e preto e transp
Tensão: bivolt
Potência: 5X5W (25W)
Soquete: G9
Medida: 13,4cmx113cmx25,7cm

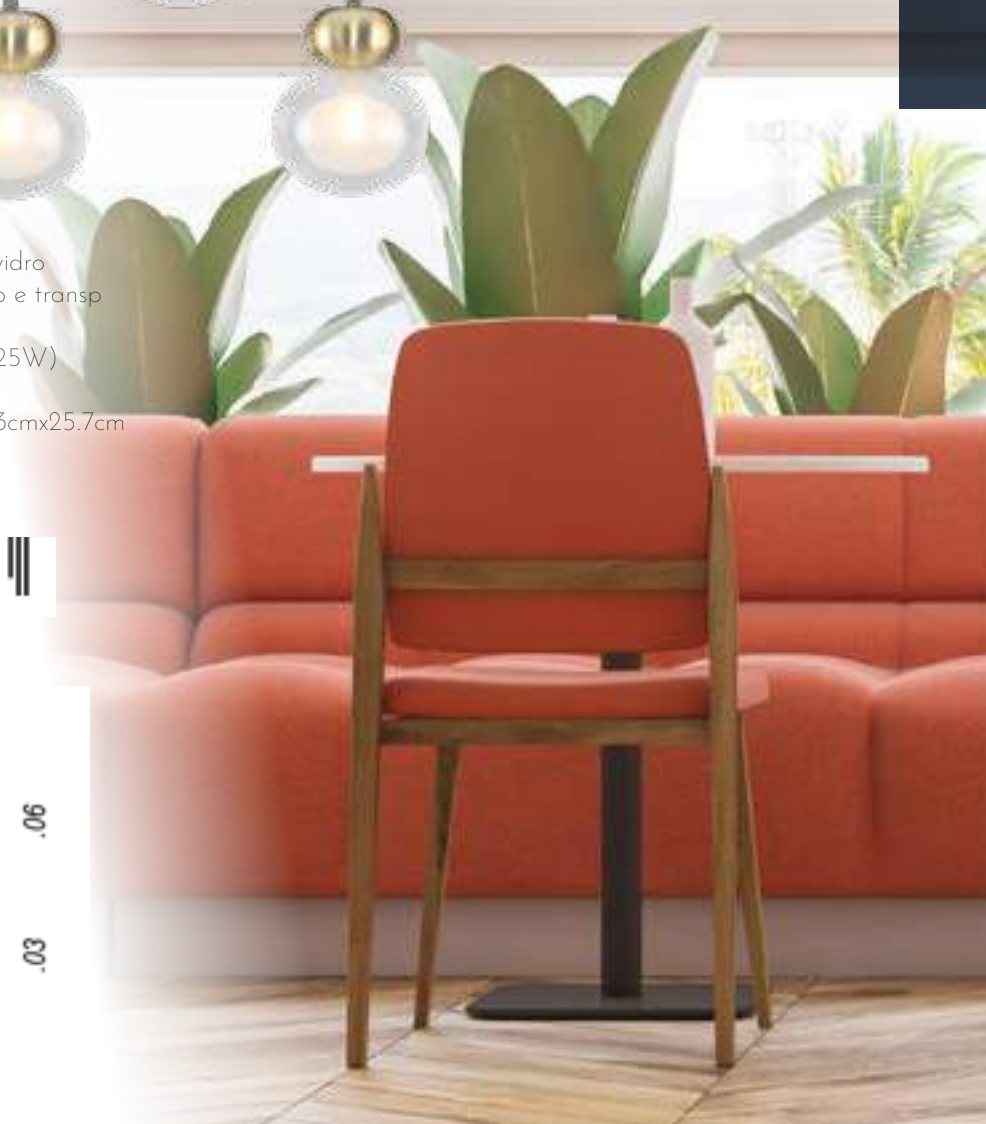
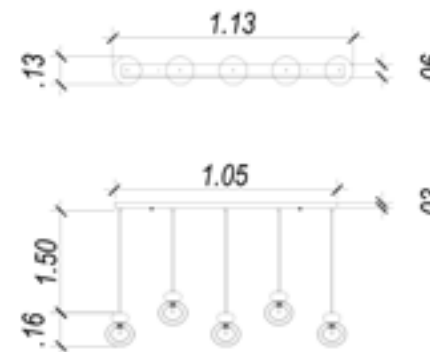



Três



PENDENTE

Três

HC016

Material: metal e vidro
Cor: preto e fume
Tensão: bivolt
Potência: 1X40W
Soquete: E27
Medida: Ø30cmx42.5cm

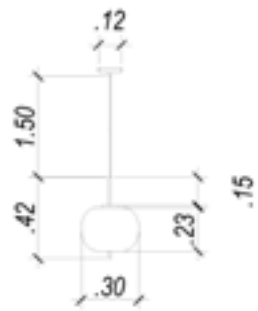

PENDENTE

Três

HC015

Material: metal e vidro
Cor: preto e fume
Tensão: bivolt
Potência: 1X40W
Soquete: E27
Medida: Ø27cmx59.5cm

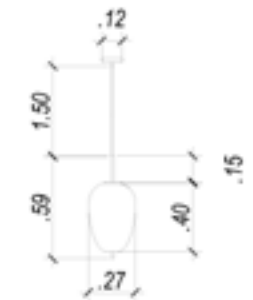

PENDENTE

Três

HC014

Material: metal e vidro
Cor: preto e fume
Tensão: bivolt
Potência: 1X40W
Soquete: E27
Medida: Ø22cmx59.5cm

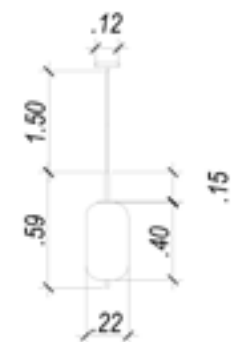

Cone



PENDENTE

Cone

RE012

Material: metal e vidro
Cor: preto e fume
Tensão: bivolt
Potência: 1X25W
Soquete: G9
Medida: Ø12cmx30cm

PENDENTE

Cone

RE013

Material: metal e vidro
Cor: preto e fume
Tensão: bivolt
Potência: 1X25W
Soquete: G9
Medida: Ø19.5cmx25cm



Asta



PENDENTE

Asta

OD039R

Material: metal e vidro
Cor: cobre e transp
Tensão: bivolt
Potência: 6X25W (150W)
Soquete: G9
Medida: Ø50cmx18cm



PENDENTE

Asta

OD039G

Material: metal e vidro
Cor: dourado e champagne
Tensão: bivolt
Potência: 6X25W (150W)
Soquete: G9
Medida: Ø50cmx18cm





Than



PENDENTE
Than
FO006S
Material: metal e vidro
Cor: antique bronze e fume
Tensão: bivolt
Potência: 1X40W
Soquete: E27
Medida: Ø16cmx31cm



PENDENTE
Than
FO006A
Material: metal e vidro
Cor: antique bronze e ambar
Tensão: bivolt
Potência: 1X40W
Soquete: E27
Medida: Ø16cmx31cm



Khao



PENDENTE
Khao
OP060CH
Material: metal e vidro
Cor: preto e champagne
Tensão: bivolt
Potência: 1X40W
Soquete: E27
Medida: Ø25cmx45cm



PENDENTE
Khao
OP060S
Material: metal e vidro
Cor: preto e fume
Tensão: bivolt
Potência: 1X40W
Soquete: E27
Medida: Ø25cmx45cm



Speculo



PENDENTE
Speculo
JO001C
Material: metal e vidro
Cor: preto e cromado
Tensão: bivolt
Potência: 1X40W
Soquete: E27
Medida: Ø30cmx27.5cm



PENDENTE
Speculo
JO001G
Material: metal e vidro
Cor: preto e dourado
Tensão: bivolt
Potência: 1X40W
Soquete: E27
Medida: Ø30cmx27.5cm



Gamboa



PENDENTE
Gamboa
PDO18S
Material: metal e vidro
Cor: cobre e champagne
Tensão: bivolt
Potência: 1X40W
Soquete: E27
Medida: Ø37cmx32cm



PENDENTE
Gamboa
PDO18L
Material: metal e vidro
Cor: cobre e champagne
Tensão: bivolt
Potência: 1X40W
Soquete: E27
Medida: Ø53cmx47cm



Guri



PENDENTE

Guri
HLO07

Material: metal e vidro
Cor: bronze e preto e transp
Tensão: bivolt
Potência: 1X40W
Soquete: E27
Medida: Ø25cmx23cm



PENDENTE

Guri
HLO05

Material: metal e vidro
Cor: bronze e preto e transp
Tensão: bivolt
Potência: 1X40W
Soquete: E27
Medida: Ø13cmx31cm

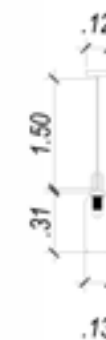

PENDENTE

Guri
HLO06

Material: metal e vidro
Cor: bronze e preto e transp
Tensão: bivolt
Potência: 1X40W
Soquete: E27
Medida: Ø15cmx41cm

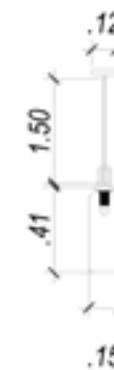

Filô



PENDENTE

Filô

RZ005

Material: metal e vidro
Cor: bronze e transp
Tensão: bivolt
Potência: 1X25W
Soquete: G9
Medida: Ø26cm x 31cm

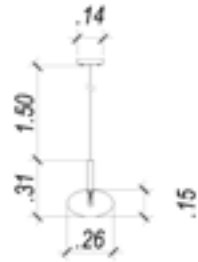

PENDENTE

Filô

RZ007

Material: metal e vidro
Cor: bronze e transp
Tensão: bivolt
Potência: 1X25W
Soquete: G9
Medida: Ø14cm x 43cm

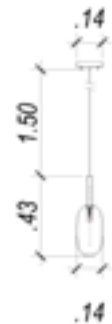

PENDENTE

Filô

RZ006

Material: metal e vidro
Cor: bronze e transp
Tensão: bivolt
Potência: 1X25W
Soquete: G9
Medida: Ø30cm x 46cm

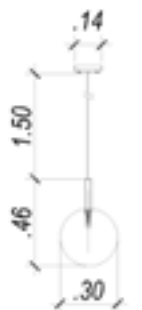

PENDENTE

Bocci

OD037SS

Material: metal e vidro
Cor: cromado e fume
Tensão: bivolt
Potência: 1X40W
Soquete: E27
Medida: Ø20,5cm



Bocci

BELLA
15 anos iluminando



PENDENTE

Bocci

OD038EM

Material: metal e vidro
Cor: cobre
Tensão: bivolt
Potência: 1X40W
Soquete: E27
Medida: Ø30cm



PENDENTE

Bocci

OD037SM

Material: metal e vidro
Cor: cromado e fume
Tensão: bivolt
Potência: 1X40W
Soquete: E27
Medida: Ø30cm



PENDENTE

Bocci

OD038ES

Material: metal e vidro
Cor: cobre
Tensão: bivolt
Potência: 1X40W
Soquete: E27
Medida: Ø20,5cm



PENDENTE

Bocci

OD037SL

Material: metal e vidro
Cor: cromado e fume
Tensão: bivolt
Potência: 1X40W
Soquete: E27
Medida: Ø41cm



PENDENTE

Bocci

OD038EL

Material: metal e vidro
Cor: cobre
Tensão: bivolt
Potência: 1X40W
Soquete: E27
Medida: Ø41cm



Orbe



PENDENTE
Orbe
OP056G
Material: metal e vidro
Cor: dourado e champagne
Tensão: bivolt
Potência: 10X40W (400W)
Soquete: E27
Medida: Ø100cmx57.5cm



PENDENTE
Orbe
OP056R
Material: metal e vidro
Cor: cobre e champagne
Tensão: bivolt
Potência: 10X40W (400W)
Soquete: E27
Medida: Ø100cmx57.5cm

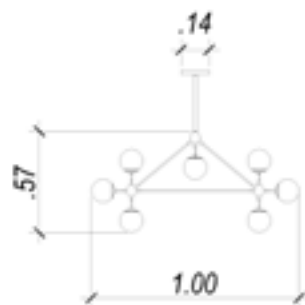

PENDENTE
Orbe
OP056
Material: metal e vidro
Cor: preto e champagne
Tensão: bivolt
Potência: 10X40W (400W)
Soquete: E27
Medida: Ø100cmx57.5cm



ARANDELA
Orbe
RM005G
Material: metal e vidro
Cor: dourado e champagne
Tensão: bivolt
Potência: 1X40W
Soquete: E27
Medida: 24cmx12.5cmx25cm



ARANDELA
Orbe
RM005B
Material: metal e vidro
Cor: preto e champagne
Tensão: bivolt
Potência: 1X40W
Soquete: E27
Medida: 24cmx12.5cmx25cm



ARANDELA
Orbe
RM005R
Material: metal e vidro
Cor: cobre e champagne
Tensão: bivolt
Potência: 1X40W
Soquete: E27
Medida: 24cmx12.5cmx25cm

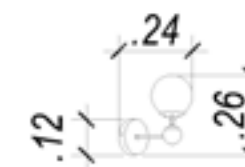



PENDENTE
Orbe
KY001S

Material: metal e vidro
Cor: preto e champagne
Tensão: bivolt
Potência: 5X40W (200W)
Soquete: E27
Medida: 40cmx80cmx95cm



PENDENTE
Orbe
KY001M

Material: metal e vidro
Cor: preto e champagne
Tensão: bivolt
Potência: 7X40W (280W)
Soquete: E27
Medida: 40cmx100cmx95cm



PENDENTE
Orbe
KY001MG

Material: metal e vidro
Cor: dourado e champagne
Tensão: bivolt
Potência: 7X40W (280W)
Soquete: E27
Medida: 40cmx100cmx95cm



PENDENTE
Orbe
KY001L

Material: metal e vidro
Cor: preto e champagne
Tensão: bivolt
Potência: 9X40W (360W)
Soquete: E27
Medida: 40cmx150cmx95cm



PENDENTE
Orbe
KY001SG

Material: metal e vidro
Cor: dourado e champagne
Tensão: bivolt
Potência: 5X40W (200W)
Soquete: E27
Medida: 40cmx80cmx95cm



PENDENTE
Orbe
KY001LG

Material: metal e vidro
Cor: dourado e champagne
Tensão: bivolt
Potência: 9X40W (360W)
Soquete: E27
Medida: 40cmx150cmx95cm





Vista

PENDENTE
Vista
 DA004
 Material: metal e vidro
 Cor: cobre e transp
 Tensão: bivolt
 Potência: 1X40W
 Soquete: E27
 Medida: Ø20cmx22cm



Rio

PENDENTE
Rio
 RZ002
 Material: metal e vidro
 Cor: nickel e fume
 Tensão: bivolt
 Potência: 6X25W (150W)
 Soquete: G9
 Medida: Ø84cmx90cm



Soho



PENDENTE /
PLAFON
Soho
PD006AM
Material: metal cristal e vidro
Cor: cromado transp e ambar
Tensão: bivolt
Potência: 9X25W (225W)
Soquete: G9
Medida: Ø60cmx28cm



PENDENTE /
PLAFON
Soho
PD001AM
Material: metal cristal e vidro
Cor: cromado transp e ambar
Tensão: bivolt
Potência: 6X25W(150W)
Soquete: G9
Medida: Ø50cmx28cm



PENDENTE /
PLAFON
Soho
PD006CO
Material: metal cristal e vidro
Cor: cromado transp e cobre
Tensão: bivolt
Potência: 9X25W (225W)
Soquete: G9
Medida: Ø60cmx28cm



PENDENTE /
PLAFON
Soho
PD006CR
Material: metal cristal e vidro
Cor: cromado e transp
Tensão: bivolt
Potência: 9X25W (225W)
Soquete: G9
Medida: Ø60cmx28cm



PENDENTE /
PLAFON
Soho
PD001CR
Material: metal cristal e vidro
Cor: cromado e transp
Tensão: bivolt
Potência: 6X25W(150W)
Soquete: G9
Medida: Ø50cmx28cm



PENDENTE /
PLAFON
Soho
PD001CO
Material: metal cristal e vidro
Cor: cromado transp e cobre
Tensão: bivolt
Potência: 6X25W (150W)
Soquete: G9
Medida: Ø50cmx28cm





PENDENTE / PLAFON
Soho
PD002AM
Material: metal cristal e vidro
Cor: cromado transp e ambar
Tensão: bivolt
Potência: 5X25W(125W)
Soquete: G9
Medida: Ø40cmx23cm



PENDENTE / PLAFON
Soho
PD002CR
Material: metal cristal e vidro
Cor: cromado e transp
Tensão: bivolt
Potência: 5X25W(125W)
Soquete: G9
Medida: Ø40cmx23cm



PENDENTE / PLAFON
Soho
PD002CO
Material: metal cristal e vidro
Cor: cromado transp e cobre
Tensão: bivolt
Potência: 5X25W(125W)
Soquete: G9
Medida: Ø40cmx23cm



PENDENTE / PLAFON
Soho
PD005AM
Material: metal cristal e vidro
Cor: cromado transp e ambar
Tensão: bivolt
Potência: 3X25W(75W)
Soquete: G9
Medida: Ø28cmx13cm



PENDENTE / PLAFON
Soho
PD005CO
Material: metal cristal e vidro
Cor: cromado transp e cobre
Tensão: bivolt
Potência: 3X25W(75W)
Soquete: G9
Medida: Ø28cmx13cm



PENDENTE / PLAFON
Soho
PD005CR
Material: metal cristal e vidro
Cor: cromado e transp
Tensão: bivolt
Potência: 3X25W(75W)
Soquete: G9
Medida: Ø28cmx13cm





PENDENTE /
PLAFON
Soho
PD007AM
Material: metal cristal e vidro
Cor: cromado transp e ambar
Tensão: bivolt
Potência: 1X25W
Soquete: G9
Medida: Ø22cmx12cm



PENDENTE /
PLAFON
Soho
PD007CR
Material: metal cristal e vidro
Cor: cromado e transp
Tensão: bivolt
Potência: 1X25W
Soquete: G9
Medida: Ø22cmx12cm



PENDENTE /
PLAFON
Soho
PD007CO
Material: metal cristal e vidro
Cor: cromado transp e cobre
Tensão: bivolt
Potência: 1X25W
Soquete: G9
Medida: Ø22cmx12cm



PENDENTE
Soho
HU6422P
Material: metal cristal e vidro
Cor: cromado e transp
Tensão: bivolt
Potência: 1X25W
Soquete: G9
Medida: Ø22cmx12cm



PENDENTE
Soho
HO7613AM
Material: metal cristal e vidro
Cor: cromado transp e ambar
Tensão: bivolt
Potência: 1X25W
Soquete: G9
Medida: Ø16cmx13cm



PENDENTE
Soho
HO7613CO
Material: metal cristal e vidro
Cor: cromado transp e cobre
Tensão: bivolt
Potência: 1X25W
Soquete: G9
Medida: Ø16cmx13cm



PENDENTE
Soho
HO7613
Material: metal, cristal e vidro
Cor: cromado e transp
Tensão: bivolt
Potência: 1X25W
Soquete: G9
Medida: Ø16cmx13cm



ARANDELA
Soho
HO7616AM
Material: metal e vidro
Cor: cr, transp e ambar
Tensão: bivolt
Potência: 1X25W
Soquete: G9
Medida: 13cmx16cmx-12cm



ARANDELA
Soho
HO7616CO
Material: metal e vidro
Cor: cr, transp e cobre
Tensão: bivolt
Potência: 1X25W
Soquete: G9
Medida: 13cmx16cmx12cm



ARANDELA
Soho
HO7616CR
Material: metal e vidro
Cor: cromado e transp
Tensão: bivolt
Potência: 1X25W
Soquete: G9
Medida: 13cmx16cmx12cm



Organika



PENDENTE
Organika
KBO01A
Material: metal e vidro
Cor: cromado e champagne
Tensão: bivolt
Potência: 1X40W
Soquete: E14
Medida: Ø13.5cmx65cm



PENDENTE
Organika
KBO01C
Material: metal e vidro
Cor: cromado e transp
Tensão: bivolt
Potência: 1X40W
Soquete: E14
Medida: Ø13.5cmx65cm



PENDENTE
Organika
KBO02A
Material: metal e vidro
Cor: cromado e champagne
Tensão: bivolt
Potência: 1X40W
Soquete: E14
Medida: Ø15.5cmx42cm



PENDENTE
Organika
KBO02C
Material: metal e vidro
Cor: cromado e transp
Tensão: bivolt
Potência: 1X40W
Soquete: E14
Medida: Ø15.5cmx42cm



Ipanema

PENDENTE

Ipanema

RM004G

Material: metal
Cor: dourado
Tensão: bivolt
Potência: 6X40W (240W)
Soquete: E27
Medida: Ø68cmx139cm

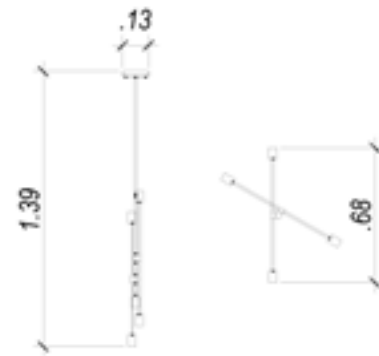

PENDENTE

Ipanema

RM003G

Material: metal
Cor: dourado
Tensão: bivolt
Potência: 4X40W (160W)
Soquete: E27
Medida: Ø68cmx139cm

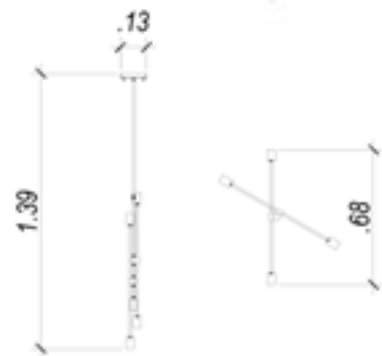

PENDENTE

Ipanema

RM004B

Material: metal
Cor: preto
Tensão: bivolt
Potência: 6X40W (240W)
Soquete: E27
Medida: Ø68cmx139cm

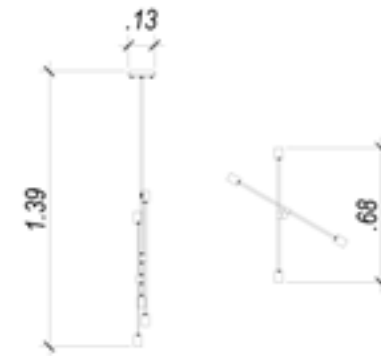

PENDENTE

Ipanema

RM003B

Material: metal
Cor: preto
Tensão: bivolt
Potência: 4X40W (160W)
Soquete: E27
Medida: Ø68cmx139cm

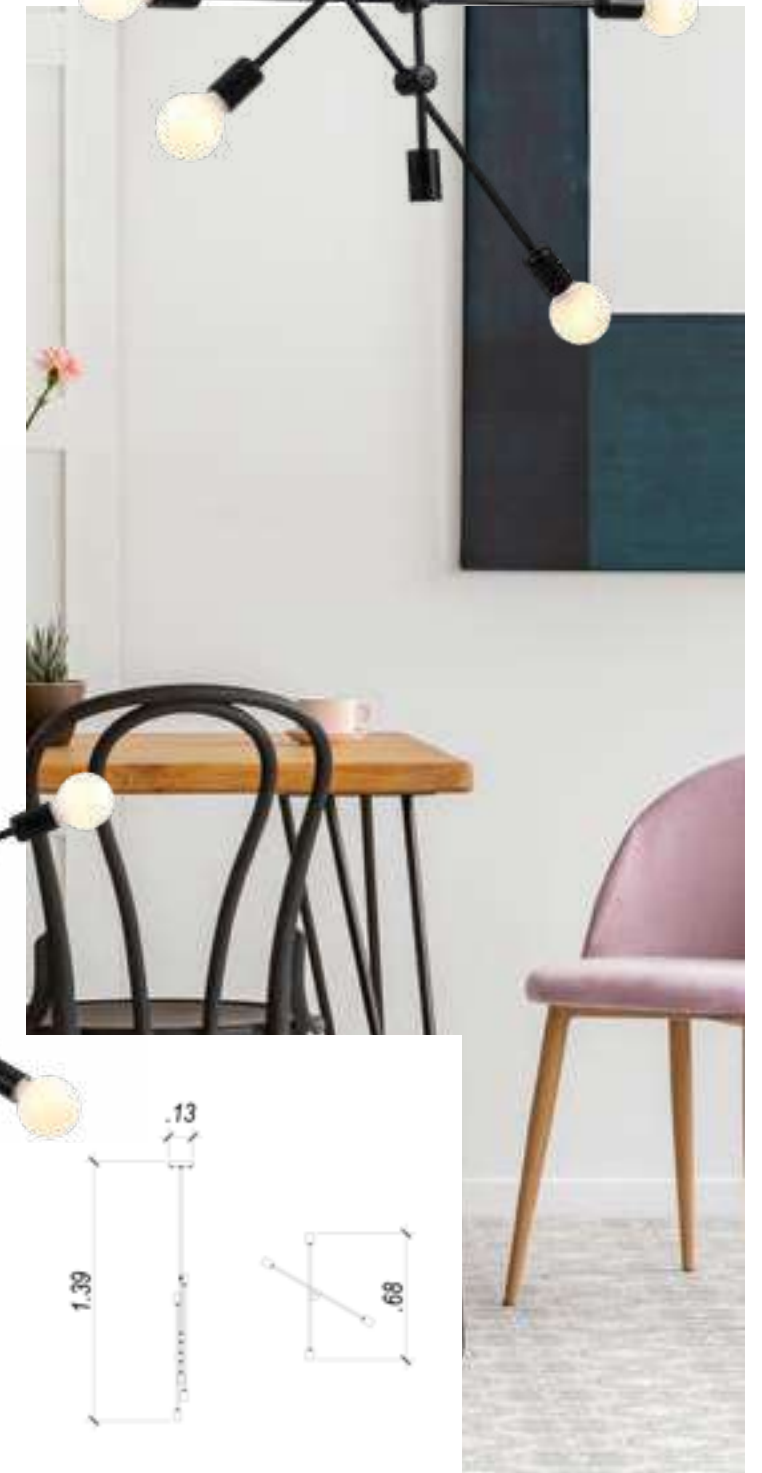
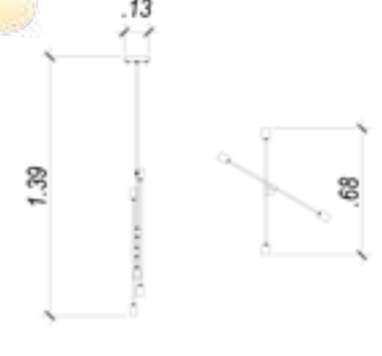

Leblon

PENDENTE
Leblon
RM001B
Material: metal
Cor: preto
Tensão: bivolt
Potência: 5X40W (200W)
Soquete: E27
Medida: Ø60cmx118cm

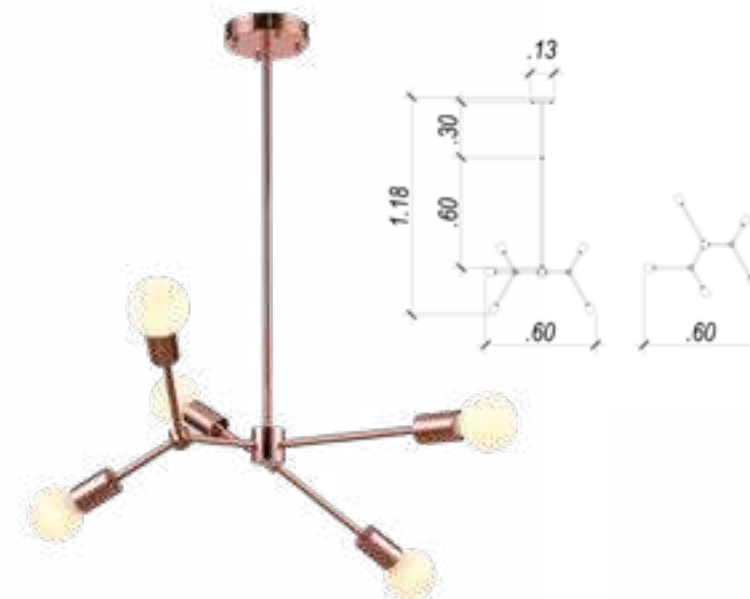

PENDENTE
Leblon
RM001R
Material: metal
Cor: rose gold
Tensão: bivolt
Potência: 5X40W (200W)
Soquete: E27
Medida: Ø60cmx118cm



PENDENTE
Leblon
RM002B
Material: metal
Cor: preto
Tensão: bivolt
Potência: 7X40W (280W)
Soquete: E27
Medida: Ø75cmx123cm



PENDENTE
Leblon
RM002R
Material: metal
Cor: rose gold
Tensão: bivolt
Potência: 7X40W (280W)
Soquete: E27
Medida: Ø75cmx123cm

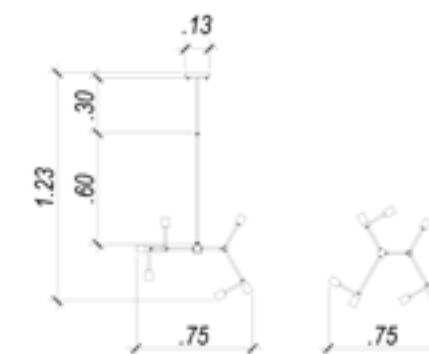



Ares

PENDENTE

Ares

EY001

Material: metal
Cor: dourado e preto
Tensão: bivolt
Potência: 6X40W (240W)
Soquete: E27
Medida: 52.5cmx58.5cmx63cm



Prih

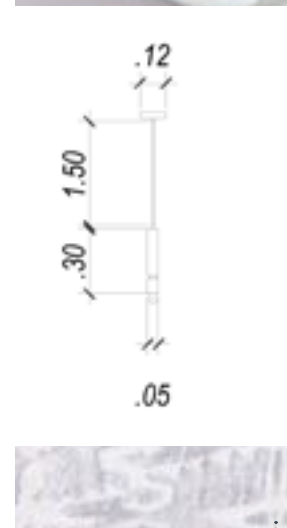

PENDENTE

Prih

HLO02

Material: metal
Cor: cobre e preto
Tensão: bivolt
Potência: 1X40W
Soquete: E27
Medida: Ø5cmx30cm



PENDENTE

Prih

HLO01

Material: metal
Cor: bronze
Tensão: bivolt
Potência: 1X40W
Soquete: E27
Medida: Ø5cmx30cm



Athena

PENDENTE

Athena

AQ029

Material: metal
Cor: french gold
Tensão: bivolt
Potência: 5X40W (200W)
Soquete: E14
Medida: Ø80cmx40cm





Spider

PENDENTE

Spider

YD006

Material: metal e acrílico
Cor: preto e branco
Tensão: bivolt
Potência: 1X7W
Soquete: G9
Medida: Ø3.6cmx13cm



*Cabo de 6m,
acompanha 3 pinos de fixação (holders)



Dio

PENDENTE

Dio

RE009

Material: metal
Cor: cromado
Tensão: bivolt
Potência: 60X7W(420W)
Soquete: E27
Medida: Ø80cmx75cm



Skopo

PENDENTE

Skopo

WN007

Material: metal
Cor: preto
Tensão: bivolt
Potência: 6X40W (240W)
Soquete: E27
Medida: 70cmx100cmx20cm



Drop

PENDENTE

Drop

HO1370B

Material: metal e vidro
Cor: cromado e transp
Tensão: 220v
Potência: 9X20W (180W)
Soquete: G4
Medida: 31cmx31cmx21cm



Cotton

PENDENTE

Cotton

AC002

Material: metal e vidro
Cor: cromado e branco
Tensão: bivolt
Potência: 1X40W
Soquete: E27
Medida: Ø24.5cmx36.5cm



Canjica

PENDENTE

Canjica

AF001

Material: metal e vidro
Cor: dourado e branco
Tensão: bivolt
Potência: 1X25W
Soquete: E27
Medida: Ø30cmx20cm





PENDENTE

Copper

XN002

Material: metal
Cor: cobre e preto
Tensão: bivolt
Potência: 1X40W
Soquete: E27
Medida: Ø18cmx23cm



PENDENTE

Copper

XN003

Material: metal
Cor: cobre e preto
Tensão: bivolt
Potência: 1X40W
Soquete: E27
Medida: Ø28cmx41cm



Copper



PENDENTE

Copper

XN004

Material: metal
Cor: cobre e preto
Tensão: bivolt
Potência: 1X40W
Soquete: E27
Medida: Ø12cmx31cm



PENDENTE

Copper

XN001

Material: metal
Cor: cobre e preto
Tensão: bivolt
Potência: 1X40W
Soquete: E27
Medida: Ø32cmx35cm



PENDENTE

Copper

XN005

Material: metal
Cor: cobre e preto
Tensão: bivolt
Potência: 1X40W
Soquete: E27
Medida: Ø50cmx48cm



Lamp

PENDENTE

Lamp

ML002W

Material: metal vidro e couro
Cor: french gold e branco
Tensão: bivolt
Potência: 1X40W
Soquete: G9
Medida: Ø18cmx22cm



ABAJUR

Lamp

ML001W

Material: metal vidro e couro
Cor: french gold e branco
Tensão: bivolt
Potência: 1X40W
Soquete: G9
Medida: Ø18cmx22cm



ABAJUR

Lamp

ML001B

Material: metal vidro e couro
Cor: dourado e preto e branco
Tensão: bivolt
Potência: 1X40W
Soquete: G9
Medida: Ø18cmx22cm



ABAJUR

Lamp

ML001G

Material: metal vidro e couro
Cor: french gold e branco
Tensão: bivolt
Potência: 1X40W
Soquete: G9
Medida: Ø18cmx22cm



PENDENTE

Lamp

ML002B

Material: metal vidro e couro
Cor: dourado e preto e branco
Tensão: bivolt
Potência: 1X40W
Soquete: G9
Medida: Ø18cmx22cm



ACESSORIO

Lamp

ML007W

Material: metal
Cor: french gold e branco
Medida: Ø10cm



ACESSORIO

Lamp

ML007B

Material: metal
Cor: dourado e preto e branco
Medida: Ø10cm



PENDENTE
Oro
ML012
Material: metal e madeira
Cor: dourado e marrom
Tensão: bivolt
Potência: 1X10W
Soquete: GU10
Medida: Ø19cmx19.5cm



Oro

PENDENTE
Oro
ML014
Material: metal e madeira
Cor: dourado e marrom
Tensão: bivolt
Potência: 1X10W
Soquete: GU10
Medida: Ø34cmx20cm



PENDENTE
Oro
ML013
Material: metal e madeira
Cor: dourado e marrom
Tensão: bivolt
Potência: 1X10W
Soquete: GU10
Medida: Ø18cmx35cm



Cage

PENDENTE
Cage
JY010
Material: metal
Cor: cobre e preto
Tensão: bivolt
Potência: 1X40W
Soquete: E27
Medida: Ø18cmx22cm

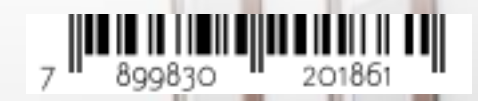



Tratto

PENDENTE

Tratto

OP027

Material: metal
Cor: preto
Tensão: bivolt
Potência: 1X40W
Soquete: E27
Medida: Ø36cmx16.5cm



Clap

PENDENTE

Clap

SE8961A

Material: metal
Cor: cobre
Tensão: bivolt
Potência: 1X40W
Soquete: E27
Medida: Ø22cmx33cm



Pin

PENDENTE

Pin

FH015A

Material: metal
Cor: cobre
Tensão: bivolt
Potência: 1X50W
Soquete: GU10
Medida: Ø12cmx11.5cm

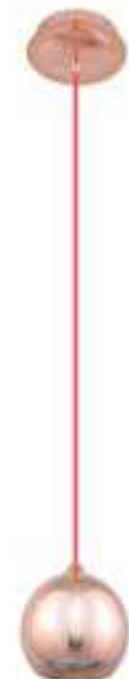



Wood

PENDENTE
Wood
LB004

Material: metal e madeira
Cor: cromado e caramelo
Tensão: bivolt
Potência: 1X40W
Soquete: E27
Medida: Ø22cmx22cm



PENDENTE
Wood
LB001

Material: metal e madeira
Cor: cromado e caramelo
Tensão: bivolt
Potência: 1X40W
Soquete: E27
Medida: Ø22cmx15cm



PENDENTE
Wood
LB002

Material: metal e madeira
Cor: cromado e caramelo
Tensão: bivolt
Potência: 1X40W
Soquete: E27
Medida: Ø30cmx20cm



PENDENTE
Wood
LB003

Material: metal e madeira
Cor: cromado e caramelo
Tensão: bivolt
Potência: 1X40W
Soquete: E27
Medida: Ø45cmx28cm



PENDENTE
Wood
LB005

Material: metal e madeira
Cor: cromado e caramelo
Tensão: bivolt
Potência: 1X40W
Soquete: E27
Medida: Ø45cmx45cm



PENDENTE
Wood
LB008

Material: metal e madeira
Cor: cromado e caramelo
Tensão: bivolt
Potência: 1X40W
Soquete: E27
Medida: Ø60cmx37cm



Pipe



COLUNA

Pipe

ME003

Material: metal e tecido
Cor: dourado e preto
Tensão: bivolt
Potência: 1X40W
Soquete: E14
Medida: Ø12cmx139cm



PENDENTE

Pipe

ME001

Material: metal e tecido
Cor: dourado e preto
Tensão: bivolt
Potência: 1X40W
Soquete: E14
Medida: Ø12cmx19.5cm



7 899830 219415



ABAJUR

Pipe

ME002

Material: metal e tecido
Cor: dourado e preto
Tensão: bivolt
Potência: 1X40W
Soquete: E14
Medida: Ø12cmx49.5cm



7 899830 219446



ARANDELA

Pipe

ME004

Material: metal e tecido
Cor: dourado e preto
Tensão: bivolt
Potência: 1X40W
Soquete: E14
Medida: Ø12cmx21cm



7 899830 219460



ARANDELA

Pipe

ME005

Material: metal madeira e tecido
Cor: dourado preto e marrom
Tensão: bivolt
Potência: 1X40W
Soquete: E14
Medida: Ø12cmx31cm



7 899830 219477



Lan

PENDENTE

Lan

XN008G

Material: metal e tecido
Cor: dourado e cinza
Tensão: bivolt
Potência: 1X40W
Soquete: E27
Medida: Ø23cmx48cm



PENDENTE

Lan

XN006G

Material: metal e tecido
Cor: dourado e cinza
Tensão: bivolt
Potência: 1X40W
Soquete: E27
Medida: Ø50cmx70cm



Scope

PENDENTE

Scope

HU1002A

Material: metal e tecido
Cor: cobre e preto
Tensão: bivolt
Potência: 1X40W
Soquete: E27
Medida: Ø25cmx142cm



PENDENTE

Scope

HU1002B

Material: metal e tecido
Cor: preto e cobre
Tensão: bivolt
Potência: 1X40W
Soquete: E27
Medida: Ø25cmx142cm



PENDENTE

Scope

HU1002C

Material: metal e tecido
Cor: cromado e branco
Tensão: bivolt
Potência: 1X40W
Soquete: E27
Medida: Ø25cmx142cm



PENDENTE

Scope

HU1002W

Material: metal e tecido
Cor: branco
Tensão: bivolt
Potência: 1X40W
Soquete: E27
Medida: Ø25cmx142cm





ABAJUR
Scope
HU3002A
Material: metal e tecido
Cor: cobre e preto
Tensão: bivolt
Potência: 1X40W
Soquete: E27
Medida: Ø15cmx72cm



ABAJUR
Scope
HU3002B
Material: metal e tecido
Cor: cobre e preto
Tensão: bivolt
Potência: 1X40W
Soquete: E27
Medida: Ø15cmx72cm



ABAJUR
Scope
HU3002C
Material: metal e tecido
Cor: cromado e branco
Tensão: bivolt
Potência: 1X40W
Soquete: E27
Medida: Ø15cmx72cm



ABAJUR
Scope
HU3002W
Material: metal e tecido
Cor: branco
Tensão: bivolt
Potência: 1X40W
Soquete: E27
Medida: Ø15cmx72cm



COLUNA
Scope
HU4002A
Material: metal e tecido
Cor: cobre e preto
Tensão: bivolt
Potência: 1X40W
Soquete: E27
Medida: Ø30cmx182cm



COLUNA
Scope
HU4002B
Material: metal e tecido
Cor: cobre e preto
Tensão: bivolt
Potência: 1X40W
Soquete: E27
Medida: Ø30cmx182cm



COLUNA
Scope
HU4002C
Material: metal e tecido
Cor: cromado e branco
Tensão: bivolt
Potência: 1X40W
Soquete: E27
Medida: Ø32cmx182cm





COLUNA

Scope

HU4003A

Material: metal e tecido
Cor: cobre e preto
Tensão: bivolt
Potência: 1X40W
Soquete: E27
Medida: Ø40cmx240cm



ARANDELA

Scope

HU5001A

Material: metal e tecido
Cor: cobre e preto
Tensão: bivolt
Potência: 1X40W
Soquete: E27
Medida: Ø15cmx67cm



COLUNA

Scope

HU4003B

Material: metal e tecido
Cor: cobre e preto
Tensão: bivolt
Potência: 1X40W
Soquete: E27
Medida: Ø40cmx240cm



ARANDELA

Scope

HU5001B

Material: metal e tecido
Cor: cobre e preto
Tensão: bivolt
Potência: 1X40W
Soquete: E27
Medida: Ø15cmx67cm



COLUNA

Scope

HU4003C

Material: metal e tecido
Cor: cromado e branco
Tensão: bivolt
Potência: 1X40W
Soquete: E27
Medida: Ø40cmx240cm



ARANDELA

Scope

HU5001C

Material: metal e tecido
Cor: cromado e branco
Tensão: bivolt
Potência: 1X40W
Soquete: E27
Medida: Ø15cmx67cm



ARANDELA

Scope

HU5001W

Material: metal e tecido
Cor: branco
Tensão: bivolt
Potência: 1X40W
Soquete: E27
Medida: Ø15cmx67cm



Fuocco

PENDENTE

Fuocco

OP8617

Material: metal e tecido
Cor: cromado e branco
Tensão: bivolt
Potência: 1X40W
Soquete: E27
Medida: 88cmx25cmx114cm



Concret

PENDENTE

Concret

ID001

Material: metal e concreto
Cor: cromado e cinza
Tensão: bivolt
Potência: 1X40W
Soquete: E27
Medida: Ø19cmx29cm



Eclipse

Arandela

Eclipse

CDO10

Material: aço alumínio e acrílico
Cor: sand gold e branco
Tensão: bivolt
Potência: 1X4W
Soquete: LED
Medida: Ø16cm x6cm
Temperatura de cor: 2700K
Fluxo luminoso: 200lm

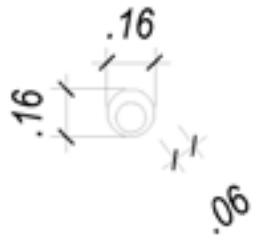

Arandela

Eclipse

CDO11

Material: aço alumínio e acrílico
Cor: sand gold e branco
Tensão: bivolt
Potência: 1X4W
Soquete: LED
Medida: 16cm x 16cm x6cm
Temperatura de cor: 2700K
Fluxo luminoso: 200lm

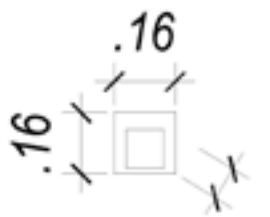

Elo

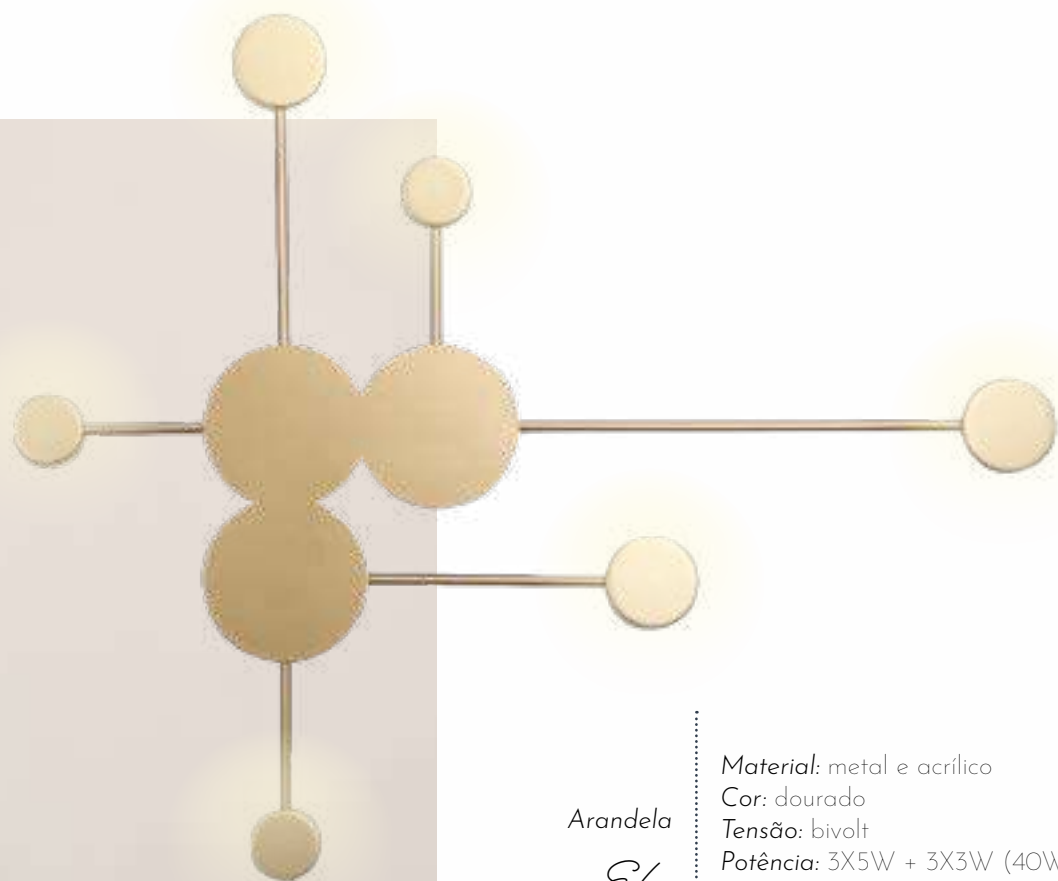

Arandela
Elo
DY003

Material: metal e acrílico
Cor: dourado
Tensão: bivolt
Potência: 3X5W + 3X3W (40W)
Soquete: LED
Medida: 74cm x 89cm x 6cm
Temperatura de cor: 3000K
Fluxo luminoso: 1200lm

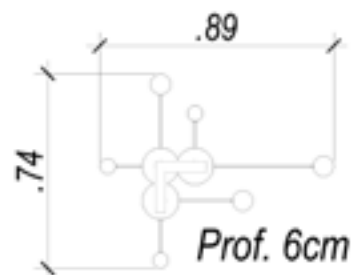

Bar



ARANDELA
Bar
OPO58C

Material: metal e vidro
Cor: cromado e branco
Tensão: bivolt
Potência: 1X40W
Soquete: G9
Medida: 22cmx14cmx17cm



ARANDELA
Bar
OPO58A

Material: metal e vidro
Cor: cobre e branco
Tensão: bivolt
Potência: 1X40W
Soquete: G9
Medida: 22cmx14cmx17cm



ARANDELA
Bar
OPO58B

Material: metal e vidro
Cor: bronze e branco
Tensão: bivolt
Potência: 1X40W
Soquete: G9
Medida: 22cmx14cmx17cm



Lina

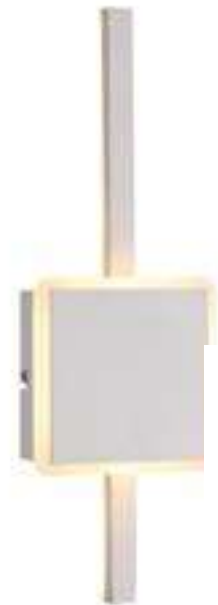

Arandela
Lina
CD003W

Material: metal
Cor: branco
Tensão: bivolt
Potência: 8W + 8W (16W)
Soquete: LED
Medida: 41,5cm x 6cm x13,6cm
Temperatura de cor: 2700K
Fluxo luminoso: 936lm

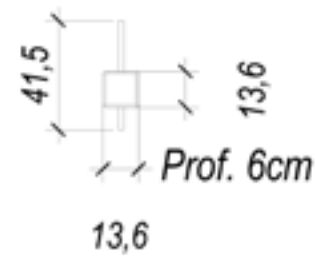

Arandela
Lina
CD003B

Material: metal
Cor: preto
Tensão: bivolt
Potência: 8W + 8W (16W)
Soquete: LED
Medida: 41,5cm x 6cm x13,6cm
Temperatura de cor: 2700K
Fluxo luminoso: 614lm

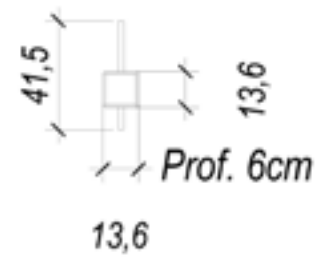

Arandela
Lina
CD004W

Material: metal
Cor: branco
Tensão: bivolt
Potência: 16W + 8W (24W)
Soquete: LED
Medida: 81,5cm x 6cm x13,6cm
Temperatura de cor: 2700K
Fluxo luminoso: 1351lm

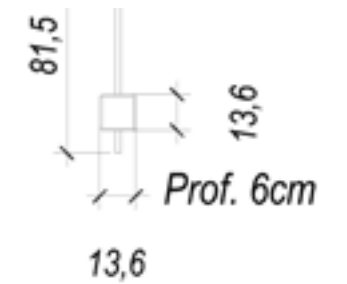

Arandela
Lina
CD004B

Material: metal
Cor: preto
Tensão: bivolt
Potência: 16W + 8W (24W)
Soquete: LED
Medida: 81,5cm x 6cm x13,6cm
Temperatura de cor: 2700K
Fluxo luminoso: 1006lm

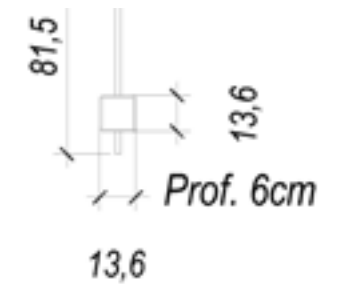

Decorativo



Linea



Arandela
Linea
JH001B

Material: metal
Cor: preto
Tensão: bivolt
Potência: 1X5W
Soquete: LED
Medida: 6cm x 14cm x30cm
Temperatura de cor: 3000K
Fluxo luminoso: 255lm



Arandela
Linea
JH001W

Material: metal
Cor: branco
Tensão: bivolt
Potência: 1X5W
Soquete: LED
Medida: 6cm x 14cm x30cm
Temperatura de cor: 3000K
Fluxo luminoso: 255lm



Arandela
Linea
JH001CR

Material: metal
Cor: cromado
Tensão: bivolt
Potência: 1X5W
Soquete: LED
Medida: 6cm x 14cm x30cm
Temperatura de cor: 3000K
Fluxo luminoso: 255lm



Arandela
Linea
JH002B

Material: metal
Cor: preto
Tensão: bivolt
Potência: 1X8W
Soquete: LED
Medida: 6cm x 14cm x46cm
Temperatura de cor: 3000K
Fluxo luminoso: 447lm



Arandela
Linea
JH002CR

Material: metal
Cor: cromado
Tensão: bivolt
Potência: 1X8W
Soquete: LED
Medida: 6cm x 14cm x46cm
Temperatura de cor: 3000K
Fluxo luminoso: 447lm



Meera



Arandela
Meera
MLO06B

Material: alumínio
Cor: preto
Tensão: bivolt
Potência: 1X6W
Soquete: LED
Medida: Ø12cm x12cm
Temperatura de cor: 3000K
Fluxo luminoso: 240lm



Arandela
Meera
MLO06W

Material: alumínio
Cor: branco
Tensão: bivolt
Potência: 1X6W
Soquete: LED
Medida: Ø12cm x12cm
Temperatura de cor: 3000K
Fluxo luminoso: 240lm



Ele



ARANDELA
Ele
MLO08B

Material: metal
Cor: preto
Tensão: bivolt
Potência: 1X40W
Soquete: E27
Medida: 19.5cmx35cmx26cm
entrada USB



ARANDELA
Ele
MLO08W

Material: metal
Cor: branco
Tensão: bivolt
Potência: 1X40W
Soquete: E27
Medida: 19.5cmx35cmx26cm
entrada USB



Arandela
Tuti
MLO11B

Material: metal e tecido
Cor: preto
Tensão: bivolt
Potência: 40W + 3W(43W)
Soquete: E27 + LED
Medida: 35cm x 26cm x36cm
Temperatura de cor: 3000K
Fluxo luminoso: 102lm
entrada USB



Tuti

Arandela
Tuti
MLO11W

Material: metal e tecido
Cor: branco e bege
Tensão: bivolt
Potência: 40W + 3W (43W)
Soquete: E27 + LED
Medida: 35cm x 26cm x36cm
Temperatura de cor: 3000K
Fluxo luminoso: 102lm
entrada USB



ARANDELA
Lera
MLO10W

Material: metal madeira e tecido
Cor: branco e marrom
Tensão: bivolt
Potência: 1X40W
Soquete: E14
Medida: 18cmx36cmx46cm



ARANDELA
Lera
MLO10B

Material: metal madeira e tecido
Cor: preto
Tensão: bivolt
Potência: 1X40W
Soquete: E14
Medida: 18cmx36cmx46cm



Lera



ARANDELA

Lettura

ZU009A

Material: metal e tecido
Cor: cromado e branco
Tensão: bivolt
Potência: 1X40W
Soquete: E27 + LED
Medida: 18cmx28cmx28cm



ARANDELA

Lettura

ZU009B

Material: metal e tecido
Cor: cromado e branco
Tensão: bivolt
Potência: 1X40W
Soquete: E27 + LED
Medida: 18cmx28cmx28cm



ARANDELA

Lettura

KD1939

Material: metal e tecido
Cor: cromado e branco
Tensão: bivolt
Potência: 1X40W
Soquete: E27
Medida: 16cmx39cmx32cm



ARANDELA

Lettura

VT2070

Material: metal e tecido
Cor: cromado e branco
Tensão: bivolt
Potência: 1X40W
Soquete: E27
Medida: 13cmx12.5cmx13cm



Lettura

Glaze



ARANDELA

Glaze

ZD2859

Material: metal e vidro
Cor: cromado e branco
Tensão: bivolt
Potência: 2X40W (80W)
Soquete: E27
Medida: 11cmx12.5cmx61cm

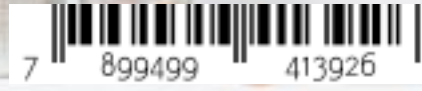

ARANDELA

Glaze

ZD2727

Material: metal e vidro
Cor: cromado e branco
Tensão: bivolt
Potência: 2X40W (80W)
Soquete: E27
Medida: 11.5cmx10.8cmx51.5cm



Decorativo

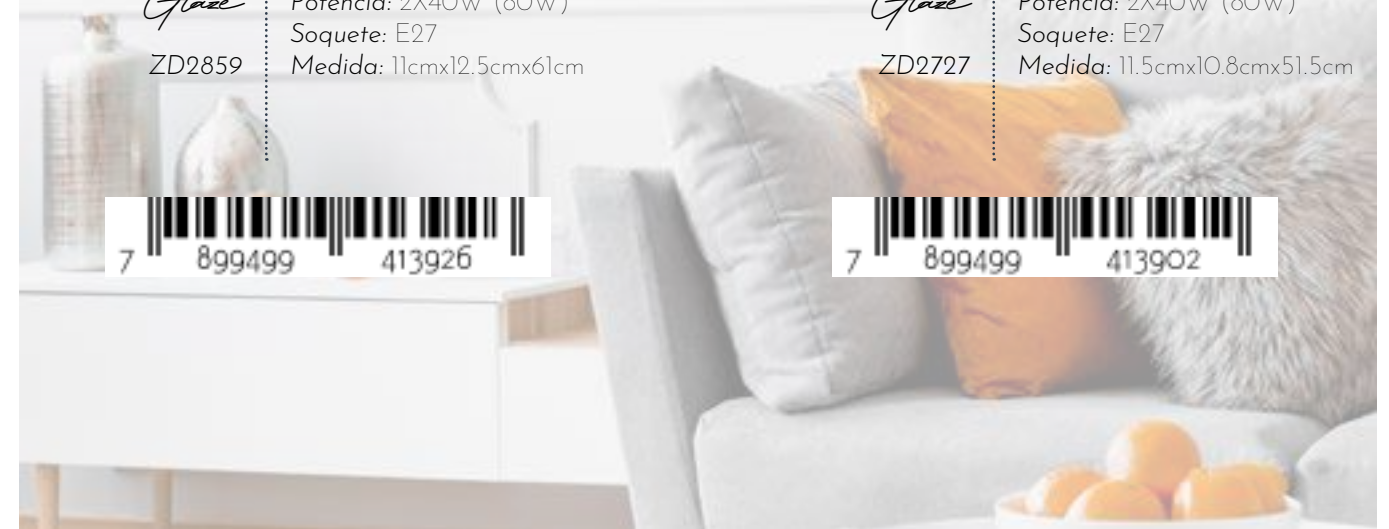

Ravel



ARANDELA

Ravel

HO110B

Material: metal e vidro
Cor: cromado e transp
Tensão: bivolt
Potência: 1X40W
Soquete: G9
Medida: 16cmx15cmx16cm



ARANDELA

Ravel

HO110A

Material: metal e vidro
Cor: cromado e transp
Tensão: bivolt
Potência: 1X40W
Soquete: G9
Medida: 13cmx15cmx13cm



ARANDELA

Ravel

HO028

Material: metal e cristal
Cor: cromado e transp
Tensão: 220v
Potência: 1X40W
Soquete: G9
Medida: Ø12cmx12cm

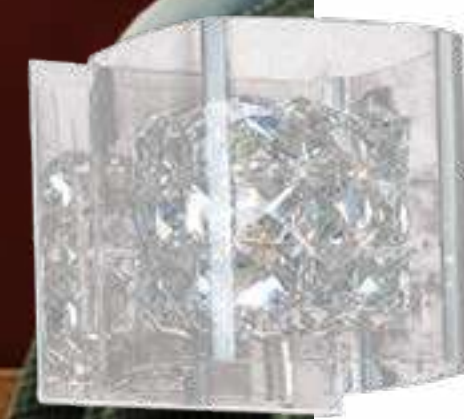

ARANDELA

Ravel

HO027

Material: metal e cristal
Cor: cromado e transp
Tensão: 220v
Potência: 1X40W
Soquete: G9
Medida: 12cmx12cmx12cm



Bell



ARANDELA

Bell

VT2041W

Material: metal e vidro
Cor: cromado e transp
Tensão: bivolt
Potência: 1X40W
Soquete: G9
Medida: 13cmx12cmx13cm



Shine



SPOT DE EMBUTIR

Shine

YD604

Material: metal e cristal
Cor: cromado e transp
Tensão: bivolt
Potência: 1X20W
Soquete: G4
Medida: 5cmx5cmx5.5cm
Nicho: 4cm



SPOT DE EMBUTIR

Shine

YD134

Material: metal e cristal
Cor: cromado e transp
Tensão: bivolt
Potência: 1X50W
Soquete: GU10
Medida: 9cmx9cmx2.5cm
Nicho: 7.5cm





SPOT DE EMBUTIR

Shine

YD101

Material: metal e cristal
Cor: cromado e transp
Tensão: bivolt
Potência: 1X50W
Soquete: GU10
Medida: Ø10cmx3cm
Nicho: 8cm



SPOT DE EMBUTIR

Shine

YD631A

Material: metal e cristal
Cor: cromado e transp
Tensão: bivolt
Potência: 1X50W
Soquete: GU10
Medida: 10cmx10cmx3cm
Nicho: 6cm



SPOT DE EMBUTIR

Shine

YD756A

Material: metal e cristal
Cor: cromado e transp
Tensão: bivolt
Potência: 1X50W
Soquete: GU10
Medida: 7cmx7cmx1.5cm
Nicho: 4,5cm



Abajures

AS BASES DE ABAJURES NÃO ACOMPANHAM CÚPULA (VENDA À PARTE)



Lettura

ABAJUR
Lettura
LI2248C

Material: metal
Cor: cromado
Tensão: bivolt
Potência: 1X40W
Soquete: G9
Medida: Ø17cmx64cm



Disk

ABAJUR
Disk
HB820

Material: metal e vidro
Cor: branco
Tensão: bivolt
Potência: 1X40W
Soquete: E27
Medida: Ø15cmx18.5cm



Nickel

ABAJUR
Nickel
LU001T

Material: metal e tecido
Cor: nickel e bege
Tensão: bivolt
Potência: 1X40W
Soquete: E27
Medida: 33cmx42cmx65cm



Telinha

ABAJUR
Telinha
CI008A

Material: metal e madeira
Cor: bronze e marrom
Tensão: bivolt
Potência: 1X40W
Soquete: E27
Medida: Ø16cmx32cm



Veneto

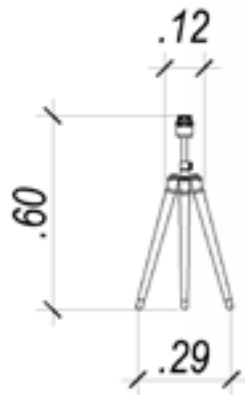

BASE PARA ABAJUR

Veneto

M1006

Material: metal e acrílico
Cor: dourado e transp
Tensão: bivolt
Potência: 1X40W
Soquete: E27
Medida: 25.5cmx29.5cmx59.5cm
Sugestão de cúpula: EX2011BR



BASE PARA ABAJUR

Veneto

M1010

Material: metal e couro
Cor: dourado e caramelo
Tensão: bivolt
Potência: 1X40W
Soquete: E27
Medida: Ø20cmx60.5cm
Sugestão de cúpula: EX2014BR



BASE PARA ABAJUR

Veneto

M1009

Material: metal e couro
Cor: dourado e caramelo
Tensão: bivolt
Potência: 1X40W
Soquete: E27
Medida: Ø17cmx58.5cm
Sugestão de cúpula: EX2011BR





BASE PARA ABAJUR

Veneto

M1007

Material: metal e vidro
Cor: dourado e transp
Tensão: bivolt
Potência: 1X40W
Soquete: E27
Medida: Ø15.5cmx53.5cm
Sugestão de cúpula: EX2014BR

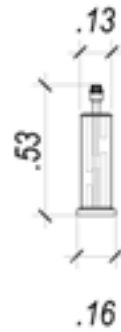

BASE PARA ABAJUR

Veneto

M1008

Material: metal e vidro
Cor: dourado e transp
Tensão: bivolt
Potência: 1X40W
Soquete: E27
Medida: Ø16cmx53cm
Sugestão de cúpula: EX2011BR



BASE PARA ABAJUR

Veneto

M1001

Material: metal
Cor: dourado e preto
Tensão: bivolt
Potência: 1X40W
Soquete: E27
Medida: Ø13cmx53.5cm
Sugestão de cúpula: EX2011PT



BASE PARA ABAJUR

Veneto

M1012

Material: metal e acrílico
Cor: dourado e preto
Tensão: bivolt
Potência: 1X40W
Soquete: E27
Medida: Ø22.5cmx50cm
Sugestão de cúpula: EX1684BR

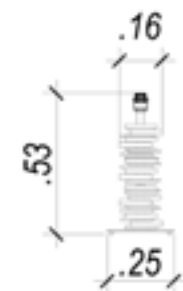

BASE PARA ABAJUR

Veneto

M1011

Material: metal e acrílico
Cor: dourado e transp
Tensão: bivolt
Potência: 1X40W
Soquete: E27
Medida: 13cmx25cmx53cm
Sugestão de cúpula: EX2014BR

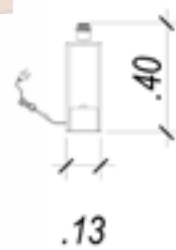

BASE PARA ABAJUR

Veneto

WRO01

Material: metal e mármore
Cor: bronze e branco
Tensão: bivolt
Potência: 1X40W
Soquete: E27
Medida: Ø12.5cmx39.6cm
Sugestão de cúpula: EX2011BR

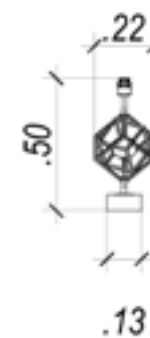

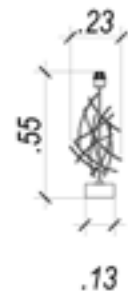

BASE PARA ABAJUR

Veneto

M1002

Material: metal
Cor: dourado
Tensão: bivolt
Potência: 1X40W
Soquete: E27
Medida: 13cmx23cmx55cm
Sugestão de cúpula: EX2011BR

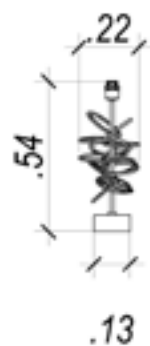

BASE PARA ABAJUR

Veneto

M1003

Material: metal
Cor: dourado
Tensão: bivolt
Potência: 1X40W
Soquete: E27
Medida: Ø13cmx54cm
Sugestão de cúpula: EX2011BR

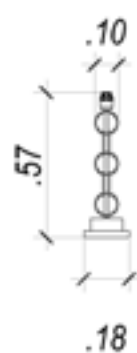

BASE PARA ABAJUR

Veneto

M1005

Material: metal e marmore
Cor: dourado e marrom
Tensão: bivolt
Potência: 1X40W
Soquete: E27
Medida: Ø18cmx57.5cm
Sugestão de cúpula: EX1684BR

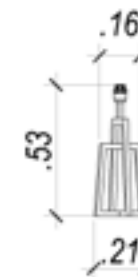

BASE PARA ABAJUR

Veneto

M1004

Material: metal
Cor: dourado
Tensão: bivolt
Potência: 1X40W
Soquete: E27
Medida: 18cmx22cmx52.5cm
Sugestão de cúpula: EX2014PT

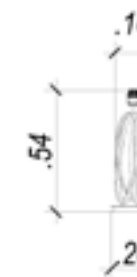

BASE PARA ABAJUR

Veneto

M1013

Material: metal
Cor: bronze
Tensão: bivolt
Potência: 1X40W
Soquete: E27
Medida: Ø20cmx54.5cm
Sugestão de cúpula: EX2014BR





BASE PARA ABAJUR

Veneto

WRO04

Material: metal e vidro
Cor: dourado e champagne
Tensão: bivolt
Potência: 1X40W
Soquete: E27
Medida: Ø22cmx52.2cm
Sugestão de cúpula: EX78BBR



BASE PARA ABAJUR

Veneto

WRO05

Material: metal e vidro
Cor: dourado e champagne
Tensão: bivolt
Potência: 1X40W
Soquete: E27
Medida: Ø19.5cmx38.5cm
Sugestão de cúpula: EX596BR



BASE PARA ABAJUR

Espelho

GL010C

Material: metal e vidro
Cor: cromado
Tensão: bivolt
Potência: 1X40W
Soquete: E27
Medida: 12cmx25cmx35cm
Sugestão de cúpula: EX2014PT



BASE PARA ABAJUR

Veneto

WRO02

Material: metal e vidro
Cor: dourado e transp
Tensão: bivolt
Potência: 1X40W
Soquete: E27
Medida: Ø20cmx54.7cm
Sugestão de cúpula: EX78BBR



BASE PARA ABAJUR

Veneto

WRO03

Material: metal e vidro
Cor: cromado
Tensão: bivolt
Potência: 1X40W
Soquete: E27
Medida: Ø26.2cmx51.2cm
Sugestão de cúpula: EX160OPT



BASE PARA ABAJUR

Espelho

GL010G

Material: metal e vidro
Cor: bronze
Tensão: bivolt
Potência: 1X40W
Soquete: E27
Medida: 12cmx25cmx35cm
Sugestão de cúpula: EX760BR



Cúpula não inclusa*



Espelho

Di



BASE PARA ABAJUR

Di

GL011

Material: metal e marmore
Cor: bronze e preto
Tensão: bivolt
Potência: 1X40W
Soquete: E27
Medida: Ø10cmx50cm
Sugestão de cúpula: EX2011PT

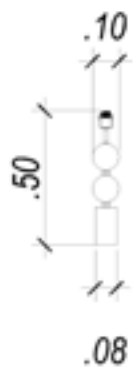

Anita



BASE PARA ABAJUR

Anita

GL009

Material: metal e marmore
Cor: dourado e preto
Tensão: bivolt
Potência: 1X40W
Soquete: E27
Medida: Ø14cmx55cm
Sugestão de cúpula: EX2011PT

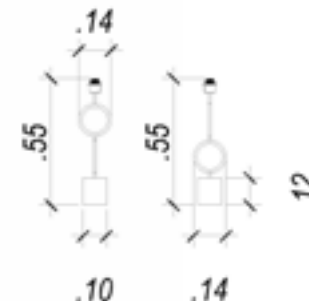

Farsila

BASE PARA ABAJUR

Farsila

GL008

Material: metal e marmore
Cor: dourado e preto
Tensão: bivolt
Potência: 1X40W
Soquete: E27
Medida: 14cmx14cmx55.5cm
Sugestão de cúpula: EX2011PT





Motif

BASE PARA ABAJUR

Material: metal
Cor: cobre
Tensão: bivolt
Potência: 1X40W
Soquete: E27
Medida: Ø12cmx39cm
Sugestão de cúpula: EX78BBR

Motif

GL003E



BASE PARA ABAJUR

Material: metal
Cor: dourado
Tensão: bivolt
Potência: 1X40W
Soquete: E27
Medida: Ø12cmx39cm
Sugestão de cúpula: EX78BBR

Motif

GL003G



Monde



BASE PARA ABAJUR

Material: metal
Cor: cobre
Tensão: bivolt
Potência: 1X40W
Soquete: E27
Medida: Ø24cmx40cm
Sugestão de cúpula: EX2011

Monde

GL004E



BASE PARA ABAJUR

Material: metal
Cor: dourado
Tensão: bivolt
Potência: 1X40W
Soquete: E27
Medida: Ø24cmx40cm
Sugestão de cúpula: EX2011

Monde

GL004G



BASE PARA ABAJUR

Material: metal
Cor: cobre
Tensão: bivolt
Potência: 1X40W
Soquete: E27
Medida: Ø15cmx39cm
Sugestão de cúpula: HU022

Disegno

GL002E



BASE PARA ABAJUR

Material: metal
Cor: dourado
Tensão: bivolt
Potência: 1X40W
Soquete: E27
Medida: Ø15cmx39cm
Sugestão de cúpula: HU022

Disegno

GL002G



Disegno

BASE PARA ABAJUR

Marmo

GLOO1GW

Material: metal e marmore
Cor: dourado e branco
Tensão: bivolt
Potência: 1X40W
Soquete: E27
Medida: Ø12cmx39cm
Sugestão de cúpula: EX1684BR



BASE PARA ABAJUR

Marmo

GLOO1GB

Material: metal e marmore
Cor: dourado e preto
Tensão: bivolt
Potência: 1X40W
Soquete: E27
Medida: Ø12cmx39cm
Sugestão de cúpula: EX1684BR



BASE PARA ABAJUR

Marmo

GLOO1EW

Material: metal e marmore
Cor: cobre e branco
Tensão: bivolt
Potência: 1X40W
Soquete: E27
Medida: Ø12cmx39cm
Sugestão de cúpula: EX1684BR



BASE PARA ABAJUR

Marmo

GLOO1EB

Material: metal e marmore
Cor: cobre e preto
Tensão: bivolt
Potência: 1X40W
Soquete: E27
Medida: Ø12cmx39cm
Sugestão de cúpula: EX1684BR



Marmo



BASE PARA ABAJUR

Classic

XL1205

Material: metal e vidro
Cor: cromado e transp
Tensão: bivolt
Potência: 1X40W
Soquete: E27
Medida: 16cmx16cmx58cm
Sugestão de cúpula: EX2219PT



BASE PARA ABAJUR

Classic

XL1206

Material: metal e vidro
Cor: cromado e transp
Tensão: bivolt
Potência: 1X40W
Soquete: E27
Medida: 13cmx13cmx49cm
Sugestão de cúpula: EX2219PT



BASE PARA ABAJUR

Classic

XL1346

Material: metal e vidro
Cor: cromado e transp e marrom
Tensão: bivolt
Potência: 1X40W
Soquete: E27
Medida: 15cmx14cmx79cm
Sugestão de cúpula: EX2014BR



BASE PARA ABAJUR

Classic

XL8204

Material: metal e vidro
Cor: cromado e transp
Tensão: bivolt
Potência: 1X40W
Soquete: E27
Medida: 12cmx12cmx50cm
Sugestão de cúpula: EX2219PT



Classic





BASE
PARA ABAJUR

Classic

XL1121

Material: metal e vidro
Cor: cromado e transp
Tensão: bivolt
Potência: 1X40W
Soquete: E27
Medida: 11cmx16cmx45cm
Sugestão de cúpula: EX2219PT



BASE
PARA ABAJUR

Classic

XL1115

Material: metal e vidro
Cor: cromado e transp
Tensão: bivolt
Potência: 1X40W
Soquete: E27
Medida: 15.2cmx22.8cmx42.8cm
Sugestão de cúpula: EX2219PT



BASE PARA ABAJUR

Classic

XL1152

Material: metal e vidro
Cor: cromado e transp
Tensão: bivolt
Potência: 1X40W
Soquete: E27
Medida: Ø12cmx61cm
Sugestão de cúpula: EX2011BR



BASE PARA ABAJUR

Classic

XL1155

Material: metal e vidro
Cor: cromado e transp
Tensão: bivolt
Potência: 1X40W
Soquete: E27
Medida: 14cmx14cmx65cm
Sugestão de cúpula: EX2014BR



BASE
PARA ABAJUR

Classic

XL1151

Material: metal e vidro
Cor: cromado e transp
Tensão: bivolt
Potência: 1X40W
Soquete: E27
Medida: Ø9cmx45cm
Sugestão de cúpula: EX2011BR



BASE
PARA ABAJUR

Classic

XL1210

Material: metal e vidro
Cor: cromado e transp
Tensão: bivolt
Potência: 1X40W
Soquete: E27
Medida: Ø15cmx55cm
Sugestão de cúpula: EX78BBR



BASE PARA ABAJUR

Scent

XL1339

Material: metal e vidro
Cor: cromado e transp
Tensão: bivolt
Potência: 1X40W
Soquete: E27
Medida: Ø16cmx53cm
Sugestão de cúpula: EX2014BR



Scent



BASE PARA ABAJUR

Scent

XL1338

Material: metal e vidro
Cor: cromado e transp
Tensão: bivolt
Potência: 1X40W
Soquete: E27
Medida: Ø12cmx43cm
Sugestão de cúpula: EX2014BR



Naif



BASE PARA ABAJUR

Naif
GLO05E

Material: metal
Cor: cobre
Tensão: bivolt
Potência: 1X40W
Soquete: E27
Medida: Ø20cmx44cm
Sugestão de cúpula: EX596BR



BASE PARA ABAJUR

Naif
GLO05G

Material: metal
Cor: dourado
Tensão: bivolt
Potência: 1X40W
Soquete: E27
Medida: Ø20cmx44cm
Sugestão de cúpula: EX596BR



Baju



ABAJUR
Baju
OPO49TS

Material: metal e tecido
Cor: cobre e preto
Tensão: bivolt
Potência: 1X40W
Soquete: E27
Medida: Ø25cmx40cm



BASE PARA ABAJUR

CLO100

Material: ceramica e metal
Cor: branco e verde
Tensão: bivolt
Potência: 1X40W
Soquete: E27
Medida: Ø25cmx49cm



Crily

BASE PARA ABAJUR

Crily
TE0127

Material: metal e acrílico
Cor: cromado e transp
Tensão: bivolt
Potência: 1X40W
Soquete: E27
Medida: Ø14cmx39cm



CLO100



Nickel

COLUNA
Nickel
LU006A

Material: metal
Cor: nickel
Tensão: bivolt
Potência: 1X40W
Soquete: E27
Medida: 25cmx25cmx164cm



COLUNA
Naif
GL006G

Material: metal
Cor: dourado
Tensão: bivolt
Potência: 1X40W
Soquete: E27
Medida: Ø28cmx133cm
Sugestão de cúpula: HU023



COLUNA
Naif
GL006E

Material: metal
Cor: cobre
Tensão: bivolt
Potência: 1X40W
Soquete: E27
Medida: Ø28cmx133cm
Sugestão de cúpula: HU023



Litro



COLUNA
Litro
GL007E

Material: metal
Cor: cobre e preto
Tensão: bivolt
Potência: 1X40W
Soquete: E27
Medida: 62cmx72cmx133cm
Sugestão de cúpula: HU023



COLUNA
Litro
GL007G

Material: metal
Cor: dourado e preto
Tensão: bivolt
Potência: 1X40W
Soquete: E27
Medida: 62cmx72cmx133cm
Sugestão de cúpula: HU023



Theo



COLUNA

Theo

EA008

Material: metal e madeira
Cor: cromado e marrom
Tensão: bivolt
Potência: 1X40W
Soquete: E27
Medida: Ø45cmx42-75cm
Sugestão de cúpula: EX2011BR



Cúpulas





CÚPULA
Pliss
Material: tecido
Cor: cru
Medida: Ø30cmx20cmx22cm
HU023



CÚPULA
Pliss
Material: tecido
Cor: cru
Medida: Ø38cmx28cmx28cm
HU022



CÚPULA
Pliss
Material: tecido
Cor: cru
Medida: Ø42cmx30cmx33cm
HU021



CÚPULA
Pliss
Material: tecido
Cor: cru
Medida: Ø48cmx38cmx35cm
HU024



CÚPULA
Mini
Material: tecido
Cor: preto
Medida: Ø12.5cmx11cm
HU051B



CÚPULA
Mini
Material: tecido
Cor: prata
Medida: Ø12.5cmx11cm
HU051S



Basic

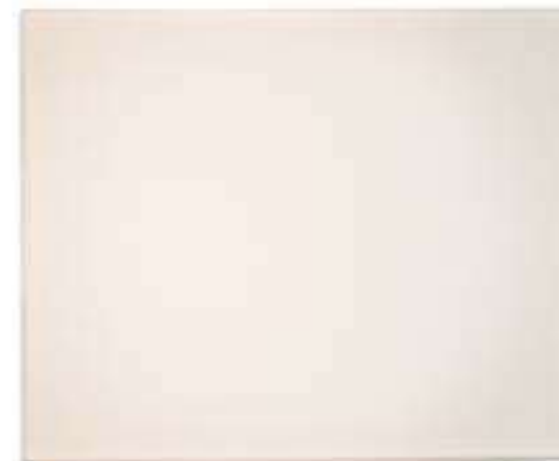

CÚPULA
Basic
Material: tecido
Cor: branco
Medida: Ø31cmx22cm
EX1315BR



CÚPULA
Basic
Material: tecido
Cor: preto
Medida: Ø31cmx22cm
EX1315PT



CÚPULA
Basic
Material: tecido
Cor: branco
Medida: Ø32cmx30cm
EX1600

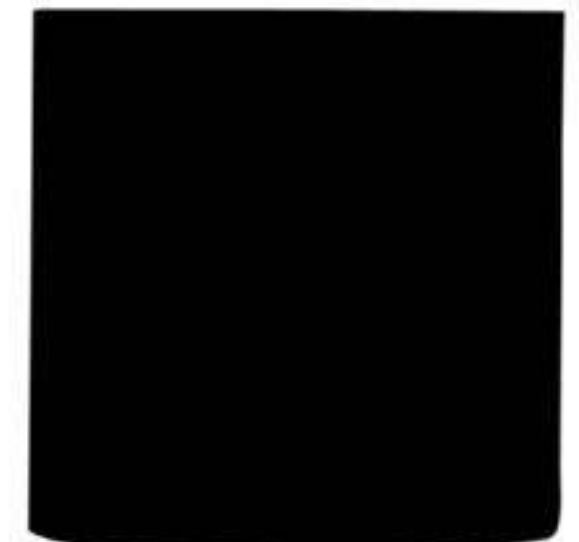

CÚPULA
Basic
Material: tecido
Cor: preto
Medida: Ø32cmx30cm
EX1600PT



Pliss

Mini



CÚPULA
Basic
Material: tecido
Cor: branco
Medida: Ø38cmX32cmx32cmx27cm
EX1684BR



CÚPULA
Basic
Material: tecido
Cor: preto
Medida: Ø38cmX32cmx32cmx27cm
EX1684PT



CÚPULA
Basic
Material: tecido
Cor: branco
Medida: Ø43cmx33cmx33cmx33cm
EX2014BR



CÚPULA
Basic
Material: tecido
Cor: preto
Medida: Ø43cm 35cmx35cmx35cm
EX2014PT



CÚPULA
Basic
Material: tecido
Cor: branco
Medida: Ø40cmx30cm
EX2011BR



CÚPULA
Basic
Material: tecido
Cor: preto
Medida: Ø40cmx30cm
EX2011PT



CÚPULA
Basic
Material: tecido
Cor: branco
Medida: 30cmx30cmx32cm
EX2064



CÚPULA
Basic
Material: tecido
Cor: preto
Medida: 30cmx30cmx32cm
EX2064PT





CÚPULA
Basic
EX2219
Material: tecido
Cor: branco
Medida: 40cmx22cmx30cm



CÚPULA
Basic
EX2219PT
Material: tecido
Cor: preto
Medida: 40cmx22cmx30cm



CÚPULA
Basic
EX2451BR
Material: tecido
Cor: branco
Medida: Ø49cmx30cm



CÚPULA
Basic
EX2451PT
Material: tecido
Cor: preto
Medida: Ø49cmx30cm



CÚPULA
Basic
EX78BPT
Material: tecido
Cor: preto
Medida: Ø30cmx20cmx20cmx22cm



CÚPULA
Basic
EX596BR
Material: tecido
Cor: branco
Medida: Ø21.5cmx15.5cm



CÚPULA
Basic
EX760BR
Material: tecido
Cor: branco
Medida: Ø20cmx18cm



CÚPULA
Basic
EX78BBR
Material: tecido
Cor: branco
Medida: Ø30cmx20cmx20cmx22cm



CÚPULA
Basic
EX760PT
Material: tecido
Cor: preto
Medida: Ø20cmx18cm





D O W N L I G H T

Conecta
Abs



lâmpada não inclusa*

SPOT DE EMBUTIR
Conecta
Abs
DL146MDW
Material: abs
Cor: branco
Tensão: Bivolt
Potência: 1X50W
Soquete: GU10
Lâmpada: MR11
Medida: 10,2cm X 10,2cm X 4,15cm
Nicho: 9,5cm X 9,5cm



SPOT DE EMBUTIR
Conecta
Abs
DL146DICW
Material: abs
Cor: branco
Tensão: Bivolt
Potência: 1X50W
Soquete: GU10
Lâmpada: MR16
Medida: 10,2cm X 10,2cm X 4,15cm
Nicho: 9,5cm X 9,5cm



SPOT DE EMBUTIR
Conecta
Abs
DL146MDB
Material: abs
Cor: preto
Tensão: Bivolt
Potência: 1X50W
Soquete: GU10
Lâmpada: MR11
Medida: 10,2cm X 10,2cm X 4,15cm
Nicho: 9,5cm X 9,5cm



SPOT DE EMBUTIR
Conecta
Abs
DL146DICB
Material: abs
Cor: preto
Tensão: Bivolt
Potência: 1X50W
Soquete: GU10
Lâmpada: MR16
Medida: 10,2cm X 10,2cm X 4,15cm
Nicho: 9,5cm X 9,5cm



SPOT DE EMBUTIR
Conecta
Abs
DL146PAR20W
Material: abs
Cor: branco
Tensão: Bivolt
Potência: 1X50W
Soquete: E27
Lâmpada: PAR20
Medida: 13cm X 13cm X 4,35cm
Nicho: 12cm X 12cm



SPOT DE EMBUTIR
Conecta
Abs
DL146PAR30W
Material: abs
Cor: branco
Tensão: Bivolt
Potência: 1X50W
Soquete: E27
Lâmpada: PAR30
Medida: 17cm X 17cm X 4,30cm
Nicho: 16cm X 16cm



SPOT DE EMBUTIR
Conecta
Abs
DL146PAR20B
Material: abs
Cor: preto
Tensão: Bivolt
Potência: 1X50W
Soquete: E27
Lâmpada: PAR20
Medida: 13cm X 13cm X 4,35cm
Nicho: 12cm X 12cm



SPOT DE EMBUTIR
Conecta
Abs
DL146PAR30B
Material: abs
Cor: preto
Tensão: Bivolt
Potência: 1X50W
Soquete: E27
Lâmpada: PAR30
Medida: 17cm X 17cm X 4,30cm
Nicho: 16cm X 16cm



SPOT DE EMBUTIR
Conecta
Abs
DL146AR70W
Material: abs
Cor: branco
Tensão: Bivolt
Potência: 1X50W
Soquete: GU10
Lâmpada: AR70
Medida: 13cm X 13cm X 4,35cm
Nicho: 12cm X 12cm



SPOT DE EMBUTIR
Conecta
Abs
DL146AR111W
Material: abs
Cor: branco
Tensão: Bivolt
Potência: 1X50W
Soquete: GU10
Lâmpada: AR111
Medida: 17cm X 17cm X 4,30cm
Nicho: 16cm X 16cm



SPOT DE EMBUTIR
Conecta
Abs
DL146AR70B
Material: abs
Cor: preto
Tensão: Bivolt
Potência: 1X50W
Soquete: GU10
Lâmpada: AR70
Medida: 13cm X 13cm X 4,35cm
Nicho: 12cm X 12cm



SPOT DE EMBUTIR
Conecta
Abs
DL146AR111B
Material: abs
Cor: preto
Tensão: Bivolt
Potência: 1X50W
Soquete: GU10
Lâmpada: AR111
Medida: 17cm X 17cm X 4,30cm
Nicho: 16cm X 16cm



acessórios

Conecta Abs



Acessório
Conecta
Abs
DL147DIC

Acessório para fixação dos Spots DL146DIC e DL146MD

Material: metal
Tensão: Bivolt
Medida: 7,8cm X 2,38cm



Acessório
Conecta
Abs
DL147PAR

Acessório para fixação dos Spots DL146AR70 e DL146PAR20

Material: metal
Tensão: Bivolt
Medida: 8,2cm X 2,25cm



Acessório
Conecta
Abs
DL147AR

Acessório para fixação dos Spots DL146AR111 e DL146PAR30

Material: metal
Tensão: Bivolt
Medida: 12cm X 2,48cm



Conecta



lâmpadas não inclusas*

SPOT DE EMBUTIR

Conecta
NS7350B



Material: aluminio
Cor: branco
Tensão: bivolt
Potência: 1X35W
Soquete: GU10
Lâmpada: MR11
Medida: Ø9cmx4.5cm
Nicho: 8.2cm

SPOT DE EMBUTIR

Conecta
NS7000B



Material: aluminio
Cor: branco
Tensão: bivolt
Potência: 1X50W
Soquete: GU10
Lâmpada: MR16
Medida: Ø10cmx3cm
Nicho: 9.5cm

SPOT DE EMBUTIR

Conecta
NS7200B



Material: aluminio
Cor: branco
Tensão: bivolt
Potência: 1X40W
Soquete: E27
Lâmpada: PAR20
Medida: Ø13cmx3.5cm
Nicho: 12cm

SPOT DE EMBUTIR

Conecta
NS7300B

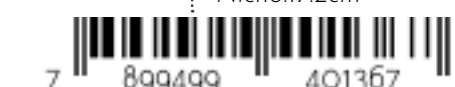

Material: aluminio
Cor: branco
Tensão: bivolt
Potência: 1X40W
Soquete: E27
Lâmpada: PAR30
Medida: Ø18cmx6cm
Nicho: 17.2cm

SPOT DE EMBUTIR

Conecta
NS7700B



Material: aluminio
Cor: branco
Tensão: bivolt
Potência: 1X50W
Soquete: GU10
Lâmpada: AR70
Medida: Ø13cmx3.5cm
Nicho: 12cm

SPOT DE EMBUTIR

Conecta
NS7110B



Material: aluminio
Cor: branco
Tensão: bivolt
Potência: 1X50W
Soquete: GU10
Lâmpada: AR111
Medida: Ø18.5cmx6.5cm
Nicho: 16.8cm



lâmpadas não inclusas*



lâmpadas não inclusas*

SPOT DE EMBUTIR

Conecta

NS7350P

Material: alumínio
Cor: branco e preto
Tensão: bivolt
Potência: 1X35W
Soquete: GU10
Lâmpada: MR11
Medida: Ø9cmx4.5cm
Nicho: 8.2cm

7 899499 401411

SPOT DE EMBUTIR

Conecta

NS7000P

Material: alumínio
Cor: branco e preto
Tensão: bivolt
Potência: 1X50W
Soquete: GU10
Lâmpada: MR16
Medida: Ø10cmx3cm
Nicho: 9.5cm

7 899499 401237

SPOT DE EMBUTIR

Conecta

NS7351B

Material: alumínio
Cor: branco
Tensão: bivolt
Potência: 1X35W
Soquete: GU10
Lâmpada: MR11
Medida: 9cmx9cmx3.5cm
Nicho: 3.5cmX7.5cmX7.5cm

7 899499 401428

SPOT DE EMBUTIR

Conecta

NS7001B

Material: alumínio
Cor: branco
Tensão: bivolt
Potência: 1X50W
Soquete: GU10
Lâmpada: MR16
Medida: 10.2cmx10.2cmx4cm
Nicho: 3cmX8.5cmX8.5cm

7 899499 401244

SPOT DE EMBUTIR

Conecta

NS7200P

Material: alumínio
Cor: branco e preto
Tensão: bivolt
Potência: 1X40W
Soquete: E27
Lâmpada: PAR20
Medida: Ø13cmx3.5cm
Nicho: 12cm

7 899499 401312

SPOT DE EMBUTIR

Conecta

NS7300P

Material: alumínio
Cor: branco e preto
Tensão: bivolt
Potência: 1X40W
Soquete: E27
Lâmpada: PAR30
Medida: Ø18cmx6cm
Nicho: 17.2cm

7 899499 401374

SPOT DE EMBUTIR

Conecta

NS7201B

Material: alumínio
Cor: branco
Tensão: bivolt
Potência: 1X40W
Soquete: E27
Lâmpada: PAR20
Medida: 13cmx13cmx4cm
Nicho: 3cmX11.5cmX11.5cm

7 899499 413971

SPOT DE EMBUTIR

Conecta

NS7301B

Material: alumínio
Cor: branco
Tensão: bivolt
Potência: 1X40W
Soquete: E27
Lâmpada: PAR30
Medida: 18.5cmx18.5cmx5cm
Nicho: 5cmX16cmX16cm

7 899499 401381

SPOT DE EMBUTIR

Conecta

NS7700P

Material: alumínio
Cor: branco e preto
Tensão: bivolt
Potência: 1X50W
Soquete: GU10
Lâmpada: AR70
Medida: Ø13cmx3.5cm
Nicho: 12cm

7 899499 401459

SPOT DE EMBUTIR

Conecta

NS7110P

Material: alumínio
Cor: branco e preto
Tensão: bivolt
Potência: 1X50W
Soquete: GU10
Lâmpada: AR111
Medida: Ø18.5cmx6.5cm
Nicho: 16.8cm

7 899499 401275

SPOT DE EMBUTIR

Conecta

NS7701B

Material: alumínio
Cor: branco
Tensão: bivolt
Potência: 1X50W
Soquete: GU10
Lâmpada: AR70
Medida: 13cmx13cmx3.5cm
Nicho: 3cmX11.5cmX11.5cm

7 899499 401466

SPOT DE EMBUTIR

Conecta

NS7111B

Material: alumínio
Cor: branco
Tensão: bivolt
Potência: 1X50W
Soquete: GU10
Lâmpada: AR111
Medida: 18cmx18cmx6.5cm
Nicho: 4cmX16cmX5cmX16.5cm

7 899499 401282



lâmpadas não inclusas*

SPOT DE EMBUTIR

Conecta

NS7351P



Material: alumínio
Cor: branco e preto
Tensão: bivolt
Potência: 1X35W
Soquete: GU10
Lâmpada: MR11
Medida: 9cmx9cmx3.5cm
Nicho: 3.5cmX7.5cmX7.5cm

SPOT DE EMBUTIR

Conecta

NS7001P



Material: alumínio
Cor: branco e preto
Tensão: bivolt
Potência: 1X50W
Soquete: GU10
Lâmpada: MR16
Medida: 10.2cmx10.2cmx4cm
Nicho: 9.5cmX9.5cm

SPOT DE EMBUTIR

Conecta

NS7201P



Material: alumínio
Cor: branco e preto
Tensão: bivolt
Potência: 1X40W
Soquete: E27
Lâmpada: PAR20
Medida: 14cmx14cmx6.5cm
Nicho: 3cmX11.5cmX11.5cm

SPOT DE EMBUTIR

Conecta

NS7301P



Material: alumínio
Cor: branco e preto
Tensão: bivolt
Potência: 1X40W
Soquete: E27
Lâmpada: PAR30
Medida: 18.5cmx18.5cmx5cm
Nicho: 5cmX16cmX16cm

SPOT DE EMBUTIR

Conecta

NS7701P



Material: alumínio
Cor: branco e preto
Tensão: bivolt
Potência: 1X50W
Soquete: GU10
Lâmpada: AR70
Medida: 13cmx13cmx3.5cm
Nicho: 3cmX11.5cmX11.5cm

SPOT DE EMBUTIR

Conecta

NS7111P



Material: alumínio
Cor: branco e preto
Tensão: bivolt
Potência: 1X50W
Soquete: GU10
Lâmpada: AR111
Medida: 18cmx18cmx6.5cm
Nicho: 4cmX16.5cmX16.5cm

Ecco



lâmpadas não inclusas*

SPOT DE EMBUTIR

Ecco

NS5101B



Material: alumínio
Cor: branco
Tensão: bivolt
Potência: 1X35W
Soquete: GU10
Lâmpada: MR11
Medida: 7.5cmx7.5cmx3cm
Nicho: 2cmX6cm

SPOT DE EMBUTIR

Ecco

NS5601B



Material: alumínio
Cor: branco
Tensão: bivolt
Potência: 1X50W
Soquete: GU10
Lâmpada: MR16
Medida: 9cmx9cmx5.8cm
Nicho: 8cm

SPOT DE EMBUTIR

Ecco

NS5201B



Material: alumínio
Cor: branco
Tensão: bivolt
Potência: 1X50W
Soquete: E27
Lâmpada: PAR20
Medida: 12cmx12cmx4cm
Nicho: 3cmX9.5cm

SPOT DE EMBUTIR

Ecco

NS5701B



Material: alumínio
Cor: branco
Tensão: bivolt
Potência: 1X50W
Soquete: GU10
Lâmpada: AR70
Medida: 12cmx12cmx8cm
Nicho: 4cmX10cm

Neo



Spot para trilho
Neo
DL143B5

Material: Alumínio
Cor: Branco
Tensão: Bivolt
Potência: **5W**
Soquete: LED
Medida: 4,3cm x 8,6cm x 10,4cm
Temperatura de cor: **2700K**
Fluxo luminoso: 350lm



Spot para trilho
Neo
DL143B5N

Material: alumínio
Cor: Branco
Tensão: Bivolt
Potência: **5W**
Soquete: Led
Medida: 4,3cm x 8,6cm x 10,4cm
Temperatura de cor: **4000K**
Fluxo luminoso: 350lm



Spot para trilho
Neo
DL143P5

Material: Alumínio
Cor: Preto
Tensão: Bivolt
Potência: **5W**
Soquete: LED
Medida: 4,3cm x 8,6cm x 10,4cm
Temperatura de cor: **2700K**
Fluxo luminoso: 350lm



Spot para trilho
Neo
DL14P5N

Material: alumínio
Cor: Preto
Tensão: Bivolt
Potência: **5W**
Soquete: Led
Medida: 4,3cm x 8,6cm x 10,4cm
Temperatura de cor: **4000K**
Fluxo luminoso: 350lm



Spot para trilho
Neo
DL143B10

Material: Alumínio
Cor: Branco
Tensão: Bivolt
Potência: **10W**
Soquete: LED
Medida: 6,9cm x 10cm x 14,2cm
Temperatura de cor: **2700K**
Fluxo luminoso: 850lm



Spot para trilho
Neo
DL143B10N

Material: alumínio
Cor: Branco
Tensão: Bivolt
Potência: **10W**
Soquete: LED
Medida: 6,9cm x 10cm x 14,2cm
Temperatura de cor: **4000K**
Fluxo luminoso: 850lm



Spot para trilho
Neo
DL143P10

Material: Alumínio
Cor: Preto
Tensão: Bivolt
Potência: **10W**
Soquete: LED
Medida: 6,9cm x 10cm x 14,2cm
Temperatura de cor: **2700K**
Fluxo luminoso: 850lm



Spot para trilho
Neo
DL143P10N

Material: alumínio
Cor: Preto
Tensão: Bivolt
Potência: **10W**
Soquete: LED
Medida: 6,9cm x 10cm x 14,2cm
Temperatura de cor: **4000K**
Fluxo luminoso: 850lm



Basic

lâmpadas não inclusas*



SPOT PARA TRILHO

Basic

DLO32B

Material: metal
Cor: branco
Tensão: bivolt
Potência: 1X50W
Soquete: GU10
Lâmpada: MR16
Medida: Ø6cmx16cm



SPOT PARA TRILHO

Basic

DLO32P

Material: metal
Cor: preto
Tensão: bivolt
Potência: 1X50W
Soquete: GU10
Lâmpada: MR16
Medida: Ø6cmx16cm



SPOT PARA TRILHO

Basic

DLO30B

Material: metal
Cor: branco
Tensão: bivolt
Potência: 1X40W
Soquete: E27
Lâmpada: PAR20
Medida: Ø6.5cmx16cm



SPOT PARA TRILHO

Basic

DLO30P

Material: metal
Cor: preto
Tensão: bivolt
Potência: 1X40W
Soquete: E27
Lâmpada: PAR20
Medida: Ø6.5cmx16cm



SPOT PARA TRILHO

Basic

DLO31P

Material: metal
Cor: preto
Tensão: bivolt
Potência: 1X50W
Soquete: E27
Lâmpada: PAR30
Medida: Ø10cmx18cm





SPOT PARA TRILHO

Beam

DL044B

Material: metal
Cor: branco
Tensão: bivolt
Potência: 1X50W
Soquete: GU10
Lâmpada: MR16
Medida: Ø6.5cmx15cm



SPOT PARA TRILHO

Beam

DL044P

Material: metal
Cor: preto
Tensão: bivolt
Potência: 1X50W
Soquete: GU10
Lâmpada: MR16
Medida: Ø6.5cmx15.5cm



SPOT PARA TRILHO

Beam

DL046B

Material: metal
Cor: branco
Tensão: bivolt
Potência: 1X40W
Soquete: E27
Lâmpada: PAR20
Medida: Ø9cmx16cm



SPOT PARA TRILHO

Beam

DL046P

Material: metal
Cor: preto
Tensão: bivolt
Potência: 1X50W
Soquete: E27
Lâmpada: PAR20
Medida: Ø9cmx16cm



SPOT PARA TRILHO

Beam

DL050B

Material: metal
Cor: branco
Tensão: bivolt
Potência: 1X40W
Soquete: E27
Lâmpada: PAR30
Medida: Ø11cmx14cm



SPOT PARA TRILHO

Beam

DL050P

Material: metal
Cor: preto
Tensão: bivolt
Potência: 1X40W
Soquete: E27
Lâmpada: PAR30
Medida: Ø11cmx14cm



SPOT PARA TRILHO

Beam

DL048BG

Material: metal
Cor: branco
Tensão: bivolt
Potência: 1X50W
Soquete: GU10
Lâmpada: AR70



SPOT PARA TRILHO

Beam

DL048PG

Material: metal
Cor: preto
Tensão: bivolt
Potência: 1X50W
Soquete: GU10
Lâmpada: AR70



Beam

lâmpadas não inclusas*



SPOT DE EMBUTIR

Pharos

DLO34B

Material: metal
Cor: branco
Tensão: bivolt
Potência: 1X50W
Soquete: GU10
Lâmpada: MR16
Medida: Ø6cmx15cm



7 899830 216391



SPOT DE EMBUTIR

Pharos

DLO34P

Material: metal
Cor: preto
Tensão: bivolt
Potência: 1X50W
Soquete: GU10
Lâmpada: MR16
Medida: Ø6.5cmx14cm



7 899830 215608



SPOT DE EMBUTIR

Pharos

DLO36B

Material: metal
Cor: branco
Tensão: bivolt
Potência: 1X50W
Soquete: E27
Lâmpada: PAR20
Medida: Ø9cmx17cm



7 899830 216407



SPOT DE EMBUTIR

Pharos

DLO36P

Material: metal
Cor: preto
Tensão: bivolt
Potência: 1X50W
Soquete: E27
Lâmpada: PAR20
Medida: Ø9cmx17cm



7 899830 203858



SPOT PARA TRILHO

Pharos

DLO40B

Material: metal
Cor: branco
Tensão: bivolt
Potência: 1X50W
Soquete: E27
Lâmpada: PAR30
Medida: Ø11cmx20cm



7 899499 426629



SPOT PARA TRILHO

Pharos

DLO40P

Material: metal
Cor: preto
Tensão: bivolt
Potência: 1X50W
Soquete: E27
Lâmpada: PAR30
Medida: Ø11cmx20cm



7 899830 206033



SPOT DE EMBUTIR

Pharos

DLO38BG

Material: metal
Cor: branco
Tensão: bivolt
Potência: 1X50W
Soquete: GU10
Lâmpada: AR70
Medida: Ø9cmx18cm



7 899830 219057



SPOT PARA TRILHO

Pharos

DLO38PG

Material: metal
Cor: preto
Tensão: bivolt
Potência: 1X50W
Soquete: GU10
Lâmpada: AR70
Medida: Ø9cmx18cm



7 899830 219064

Pharos

lâmpadas não inclusas*

Trilhos eletrificados e Acessórios



Trilho de embutir
DL155W

Material: alumínio
Cor: branco
Tensão: Bivolt
Potência: 100W max
Medida: 1m



Trilho de embutir
DL156W

Material: alumínio
Cor: branco
Tensão: Bivolt
Potência: 200W max
Medida: 2m



Trilho de embutir
DL155B

Material: alumínio
Cor: preto
Tensão: Bivolt
Potência: 100W max
Medida: 1m



Trilho de embutir
DL156B

Material: alumínio
Cor: preto
Tensão: Bivolt
Potência: 200W max
Medida: 2m



Trilho de sobrepor
DL019BT

Material: alumínio
Cor: branco
Tensão: Bivolt
Potência: 200W max
Medida: 1mx3cmx2cm



Trilho de sobrepor
DL020BT

Material: alumínio
Cor: branco
Tensão: Bivolt
Potência: 200W max
Medida: 2mx3cmx2cm



Trilho de sobrepor
DL019PT

Material: alumínio
Cor: preto
Tensão: Bivolt
Potência: 200W max
Medida: 1mx3cmx2cm



Trilho de sobrepor
DL020PT

Material: alumínio
Cor: preto
Tensão: Bivolt
Potência: 200W max
Medida: 2mx3cmx2cm





Conector trilho de sobrepor

Material: aluminio
Cor: branco
Medida: 8cmx3.5cmx2cm

DLO23B



Conector trilho de sobrepor

Material: aluminio
Cor: preto
Medida: 8cmx3.5cmx2cm

DLO23P



Conector trilho de sobrepor

Material: aluminio
Cor: branco
Medida: 9.5cmx8cmx2cm

DLO24B



Conector trilho de sobrepor

Material: aluminio
Cor: preto
Medida: 9.5cmx8cmx2cm

DLO24P



Conector trilho de sobrepor

Material: aluminio
Cor: branco
Medida: 10.5cmx7.5cmx2.5cm

DLO25B



Conector trilho de sobrepor

Material: aluminio
Cor: preto
Medida: 10.5cmx7.5cmx2.5cm

DLO25P



Conector trilho de sobrepor

Material: aluminio
Cor: branco
Medida: 10.5cmx3.5cmx2cm

DLO26B



Conector trilho de sobrepor

Material: aluminio
Cor: preto
Medida: 10.5cmx3.5cmx2cm

DLO26P





*Ponteira trilho
de sobrepor*

Material: aluminio
Cor: branco

DL027B



*Ponteira trilho
de sobrepor*

Material: aluminio
Cor: preto

DL027P



*Adaptador trilho
de sobrepor*

Material: aluminio
Cor: branco
Medida: 4cmx4cmx3.5cm

DL022B



*Adaptador trilho
de sobrepor*

Material: aluminio
Cor: preto
Medida: 4cmx4cmx3.5cm

DL022P



Tampa Cega

Material: metal
Cor: branco
Medida: Ø11cmx0.2cm

DL028B



Tampa Cega

Material: metal
Cor: preto
Medida: Ø11cmx0.2cm

DL028P



Spot de sobrepor
Dot
DL148W

Material: alumínio
Cor: branco
Tensão: Bivolt
Potência: 10W
Soquete: LED
Medida: 6cm x 10,3cm
Temperatura de cor: 3000K
Fluxo luminoso: 600lm



Spot de sobrepor
Dot
DL149W

Material: alumínio
Cor: branco
Tensão: Bivolt
Potência: 20W
Soquete: LED
Medida: 9,3cm x 12,2cm
Temperatura de cor: 3000K
Fluxo luminoso: 1200lm



Spot de sobrepor
Dot
DL148B

Material: alumínio
Cor: preto
Tensão: Bivolt
Potência: 10W
Soquete: LED
Medida: 6cm x 10,3cm
Temperatura de cor: 3000K
Fluxo luminoso: 600lm



Spot de sobrepor
Dot
DL149B

Material: alumínio
Cor: preto
Tensão: Bivolt
Potência: 20W
Soquete: LED
Medida: 9,3cm x 12,2cm
Temperatura de cor: 3000K
Fluxo luminoso: 1200lm



spot de sobrepor
Box
DL145W

Material: ABS
Cor: branco
Tensão: Bivolt
Potência: 1X50W
Soquete: GU10
Lâmpada: MR16 (não inclusa)
Medida: 9,6cm X 9,6cm X 10cm



spot de sobrepor
Box
DL145B

Material: ABS
Cor: preto
Tensão: Bivolt
Potência: 1X50W
Soquete: GU10
Lâmpada: MR16 (não inclusa)
Medida: 9,6cm X 9,6cm X 10cm



arandela
Cubo
DL154W

Material: alumínio
Cor: branco
Tensão: Bivolt
Potência: 4W
Soquete: LED
Medida: 12cm x 12cm x 5,2cm
Temperatura de cor: 3000K
Fluxo luminoso: 260lm
IP: 65



arandela
Cubo
DL154B

Material: alumínio
Cor: preto
Tensão: Bivolt
Potência: 4W
Soquete: LED
Medida: 12cm x 12cm x 5,2cm
Temperatura de cor: 3000K
Fluxo luminoso: 260lm
IP: 65



Dot

Box

Cubo



FACHO DUPLO

ARANDELA

Tip

DL153W



Material: alumínio
Cor: branco
Tensão: Bivolt
Potência: 4W
Soquete: LED
Medida: 8,3cm x 3cm x 12,3cm
Temperatura de cor: 3000K
Fluxo luminoso: 130lm
IP: 65



FACHO DUPLO

ARANDELA

Tip

DL153B



Material: alumínio
Cor: preto
Tensão: Bivolt
Potência: 4W
Soquete: LED
Medida: 8,3cm x 3cm x 12,3cm
Temperatura de cor: 3000K
Fluxo luminoso: 130lm
IP: 65

Low Frame



BALIZADOR

Picto

DL150



Material: alumínio
Cor: branco
Tensão: Bivolt
Potência: 2W
Soquete: LED
Medida: 4,8cm x 8,2cm
Temperatura de cor: 3000K
Fluxo luminoso: 70lm
IP: 45

Picto

BALIZADOR

Picto

DL151



Material: alumínio
Cor: branco
Tensão: Bivolt
Potência: 2W
Soquete: LED
Medida: 4,8cm x 4,8cm x 8,2cm
Temperatura de cor: 3000K
Fluxo luminoso: 70lm
IP: 45

PLAFON DE EMBUTIR

Low Frame

DLD006Q



Material: **Alumínio**
Cor: Branco
Tensão: Bivolt
Potência: **6W**
Fluxo luminoso: 390lm
Temperatura de cor: **3000K**
Medida: 9cm x 9cm x 2cm
Nicho: 7,5cm X 7,5cm

PLAFON DE EMBUTIR

Low Frame

DLD006N



Material: **Alumínio**
Cor: Branco
Tensão: Bivolt
Potência: **6W**
Fluxo luminoso: 390lm
Temperatura de cor: **4000K**
Medida: 9cm x 9cm x 2cm
Nicho: 7,5cm X 7,5cm

PLAFON DE EMBUTIR

Low Frame

DLD012Q



Material: **Alumínio**
Cor: Branco
Tensão: Bivolt
Potência: **12W**
Fluxo luminoso: 900lm
Temperatura de cor: **3000K**
Medida: 12cm X 12cm x 2cm
Nicho: 10cm X 10cm

PLAFON DE EMBUTIR

Low Frame

DLD012N



Material: **Alumínio**
Cor: Branco
Tensão: Bivolt
Potência: **12W**
Fluxo luminoso: 900lm
Temperatura de cor: **4000K**
Medida: 12cm X 12cm x 2cm
Nicho: 10cm X 10cm

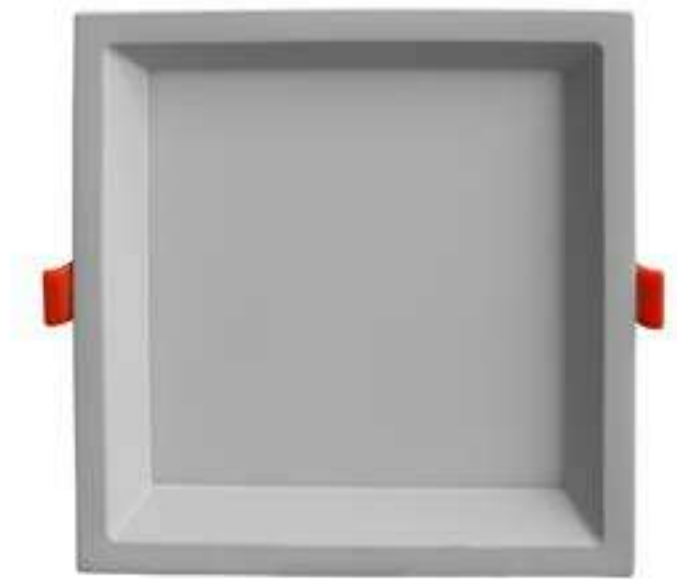

PLAFON DE
EMBUTIR

*Low
Frame*
DLDO18Q

Material: **Alumínio**
Cor: Branco
Tensão: Bivolt
Potência: **18W**
Fluxo luminoso: 1350lm
Temperatura de cor: **3000K**
Medida: 17cm X 17cm x 2cm
Nichos: 15cm X 15cm



PLAFON DE
EMBUTIR

*Low
Frame*
DLDO18N

Material: **Alumínio**
Cor: Branco
Tensão: Bivolt
Potência: **18W**
Fluxo luminoso: 1350lm
Temperatura de cor: **4000K**
Medida: 17cm X 17cm x 2cm
Nichos: 15cm X 15cm



PLAFON DE
EMBUTIR

*Low
Frame*
DLDO24Q

Material: **Alumínio**
Cor: Branco
Tensão: Bivolt
Potência: **24W**
Fluxo luminoso: 1800lm
Temperatura de cor: **3000K**
Medida: 22,5cm X 22,5cm x 2cm
Nichos: 20cm X 20cm



PLAFON DE
EMBUTIR

*Low
Frame*
DLDO24N

Material: **Alumínio**
Cor: Branco
Tensão: Bivolt
Potência: **24W**
Fluxo luminoso: 1800lm
Temperatura de cor: **4000K**
Medida: 22,5cm X 22,5cm x 2cm
Nichos: 20cm X 20cm



New Smart



PAINÉIS DE 18W

PLAFON DE
EMBUTIR

New Smart
DL180EQ

Material: **Alumínio**
Cor: Branco
Tensão: Bivolt
Potência: **18W**
Fluxo luminoso: 1200lm
Temperatura de cor: **3000K**
Medida: 21cm x21cm x 1,5cm
Nichos: 20cmX20cm



PLAFON DE
EMBUTIR

New Smart
L180EF

Material: **Alumínio**
Cor: Branco
Tensão: Bivolt
Potência: **18W**
Fluxo luminoso: 1200lm
Temperatura de cor: **6000K**
Medida: 21cm x21cm x1,5cm
Nichos: 20X20



PLAFON DE
SOBREPOR

New Smart
DL180SQ

Material: **Alumínio**
Cor: Branco
Tensão: Bivolt
Potência: **18W**
Fluxo luminoso: 1200lm
Temperatura de cor: **3000K**
Medida: 21cm x 21cm x2,8cm



PLAFON DE
SOBREPOR

New Smart
DL180SF

Material: **Alumínio**
Cor: Branco
Tensão: Bivolt
Potência: **18W**
Fluxo luminoso: 1200lm
Temperatura de cor: **6000K**
Medida: 21cm x 21cm x2,8cm





PAINÉIS DE 24W



PAINÉIS DE 30W

PLAFON DE
EMBUTIR

New Smart
DL240EQ

Material: **Alumínio**
Cor: Branco
Tensão: Bivolt
Potência: **24W**
Fluxo luminoso: 1600lm
Temperatura de cor: **3000K**
Medida: 29,1cm x 29,1cm x 1,5cm
Nichos: 27cm X 27cm



PLAFON DE
EMBUTIR

New Smart
DL240EF

Material: **Alumínio**
Cor: Branco
Tensão: Bivolt
Potência: **24W**
Fluxo luminoso: 1600lm
Temperatura de cor: **6000K**
Medida: 29,1cm x 29,1cm x 1,5cm
Nichos: 27cm X 27cm



PLAFON DE
EMBUTIR

New Smart
DL300EQ

Material: **Alumínio**
Cor: Branco
Tensão: Bivolt
Potência: **30W**
Fluxo luminoso: 2500lm
Temperatura de cor: **3000K**
Medida: 40cm x 40cm x 1,5cm
Nichos: 38cm X 38cm



PLAFON DE
EMBUTIR

New Smart
DL300EF

Material: **Alumínio**
Cor: Branco
Tensão: Bivolt
Potência: **30W**
Fluxo luminoso: 2500lm
Temperatura de cor: **6000K**
Medida: 40cm x 40cm x 1,5cm
Nichos: 38cm X 38cm



PLAFON DE
SOBREPOR

New Smart
DL240SQ

Material: **Alumínio**
Cor: Branco
Tensão: Bivolt
Potência: **24W**
Fluxo luminoso: 1600lm
Temperatura de cor: **3000K**
Medida: 28,3cm x 28,3cm x 2,8cm



PLAFON DE
SOBREPOR

New Smart
DL240SF

Material: **Alumínio**
Cor: Branco
Tensão: Bivolt
Potência: **24W**
Fluxo luminoso: 1600lm
Temperatura de cor: **6000K**
Medida: 28,3cm x 28,3cm x 2,8cm



PLAFON DE
SOBREPOR

New Smart
DL300SQ

Material: **Alumínio**
Cor: Branco
Tensão: Bivolt
Potência: **30W**
Fluxo luminoso: 2500lm
Temperatura de cor: **3000K**
Medida: 40cm x 40cm x 3,5cm



PLAFON DE
SOBREPOR

New Smart
DL300SF

Material: **Alumínio**
Cor: Branco
Tensão: Bivolt
Potência: **30W**
Fluxo luminoso: 2500lm
Temperatura de cor: **6000K**
Medida: 40cm X 40cm x 3,5cm



Accessório

D O W N L I G H T



ACESSÓRIO

Accessório

DL142BR

Material: metal
Cor: branco



LÂMPADA MR11 MINI DICROICA

LP213C

Potência
4W
Equivalência
25W

3000K - Branco quente

⚠ Não Dimerizável

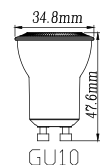

Base: GU10
Bulbo: MR11
Tensão: 127V- 220V (Bivolt)
Temperatura da Cor: 3000K
Frequência: 60Hz
Fator da Potência: 0,5
Corrente Nominal: 127V-70mA
220V-40mA
Fluxo Luminoso: 250lm
Eficiência Luminosa: 62,5lm/W
Ângulo de Abertura: 38°
IRC: RA>80
Vida Útil: 25000h
Temperatura de operação: -20°C -45°C
Tamanho: 35mmX48mm

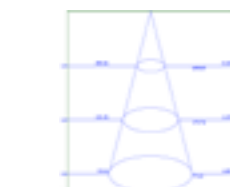

LÂMPADA MR11 MINIDICROICA

LP215C

Potência
4W
Equivalência
25W

3000K - Branco quente

⚠ Dimerizável

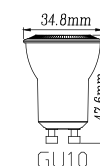

Base: GU10
Bulbo: MR11
Tensão: 127V- 220V (Bivolt)
Temperatura da Cor: 3000K
Frequência: 60Hz
Fator da Potência: 0,5
Corrente Nominal: 127V-70mA
220V-40mA
Fluxo Luminoso: 250lm
Eficiência Luminosa: 62,5lm/W
Ângulo de Abertura: 38°
IRC: RA>80
Vida Útil: 25000h
Temperatura de operação: -20°C -45°C
Tamanho: 35mmX48mm



LÂMPADA MR16 DICROICA

LP214C

Potência
7W
Equivalência
50W

3000K - Branco quente

⚠ Não Dimerizável

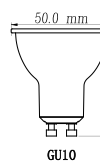

Base: GU10
Bulbo: MR16
Tensão: 127V- 220V (Bivolt)
Temperatura da Cor: 3000K
Frequência: 60Hz
Fator da Potência: 0,7
Corrente Nominal: 127V-70mA
220V-50mA
Fluxo Luminoso: 525lm
Eficiência Luminosa: 75lm/W
Ângulo de Abertura: 38°
IRC: RA>80
Vida Útil: 25000h
Temperatura de operação: -20°C -45°C
Tamanho: 50mmx53,5mm



LÂMPADA MR16 DICROICA

LP216C

Potência
7W
Equivalência
50W

3000K - Branco quente

⚠ Dimerizável

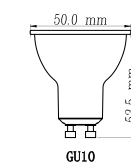

Base: GU10
Bulbo: MR16
Tensão: 127V- 220V (Bivolt)
Temperatura da Cor: 3000K
Frequência: 60Hz
Fator da Potência: 0,7
Corrente Nominal: 127V-70mA
220V-50mA
Fluxo Luminoso: 525lm
Eficiência Luminosa: 75lm/W
Ângulo de Abertura: 38°
IRC: RA>80
Vida Útil: 25000h
Temperatura de operação: -20°C -45°C
Tamanho: 50mmX53,5mm

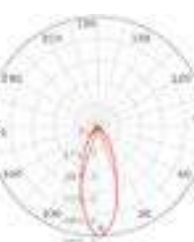

LÂMPADA PAR20

LP201C

Potência
8W
Equivalência
50W

3000K - Branco quente

⚠ Não Dimerizável

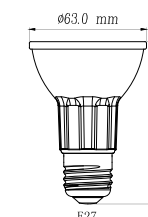

Base: E27
Bulbo: PAR20
Tensão: 127V- 220V (Bivolt)
Temperatura da Cor: 3000K
Frequência: 60Hz
Fator da Potência: 0,7
Corrente Nominal: 127V -100mA
220V-60mA
Fluxo Luminoso: 525lm
Eficiência Luminosa: 65,6lm/W
Ângulo de Abertura: 38°
IRC: RA>80
Vida Útil: 25000h
Temperatura de operação: -20°C -45°C
Tamanho: 63mmX87,5mm

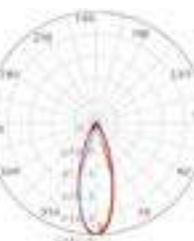

LÂMPADA PAR20

LP217C

Potência
8W
Equivalência
50W

3000K - Branco quente

⚠ Dimerizável

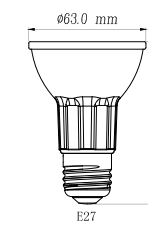

Base: E27
Bulbo: PAR20
Tensão: 127V- 220V (Bivolt)
Temperatura da Cor: 3000K
Frequência: 60Hz
Fator da Potência: 0,7
Corrente Nominal: 127V - 100mA
220V-60mA
Fluxo Luminoso: 525lm
Eficiência Luminosa: 65,6lm/W
Ângulo de Abertura: 38°
IRC: RA>80
Vida Útil: 25000h
Temperatura de operação: -20°C -45°C
Tamanho: 63mmx87,5mm

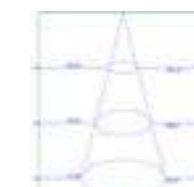

LÂMPADA PAR30

LP202C

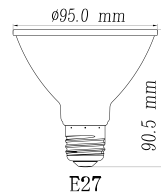

Potência **11W**
Equivalência **65W**

3000K - Branco quente

⊗ Não Dimerizável



Base: E27
Bulbo: PAR30
Tensão: 127V- 220V (Bivolt)
Temperatura da Cor: 3000K
Frequência: 60Hz
Fator da Potência: 0,7
Corrente Nominal: 127V - 140mA
220V-80mA
Fluxo Luminoso: 720lm
Eficiência Luminosa: 65lm/W
Ângulo de Abertura: 35°
IRC: RA>80
Vida Útil: 25000h
Temperatura de operação: -20°C -45°C
Tamanho: 9mmx90,5mm

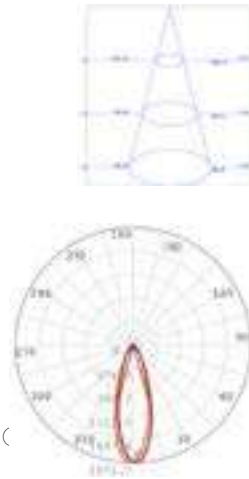

LÂMPADA AR111

LP219C

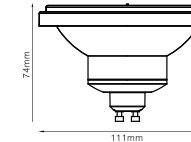

Potência **12W**
Equivalência **65W**

2700K - Branco quente

⊗ Não Dimerizável



Base: GU10
Bulbo: AR111
Tensão: 127V- 220V (Bivolt)
Temperatura da Cor: 2700K
Frequência: 60Hz
Fator da Potência: >0,7
Corrente Nominal: 0,094A (127V) 0,056A (220V)
Fluxo Luminoso: 950lm
Eficiência Luminosa: 79 lm/W
Ângulo de Abertura: 24°
IRC: RA>80
Vida Útil: 25000h
Temperatura de operação: -20°C -45°C
Tamanho: 74mmx111mm

LÂMPADA AR70

LP218C

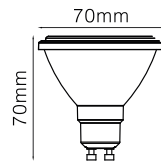

Potência **4,8W**
Equivalência **65W**

2700K - Branco quente

⊗ Não Dimerizável



Base: GU10
Bulbo: AR70
Tensão: 127V- 220V (Bivolt)
Temperatura da Cor: 2700K
Frequência: 60Hz
Fator da Potência: >0,4
Corrente Nominal: 0,038A (127V) 0,022A (220V)
Fluxo Luminoso: 300lm
Eficiência Luminosa: 63lm/W
Ângulo de Abertura: 24°
IRC: RA>80
Vida Útil: 25000h
Temperatura de operação: -20°C -45°C
Tamanho: 70mmx70mm

LÂMPADA AR111

LP221C

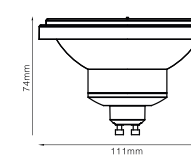

Potência **12W**
Equivalência **65W**

2700K - Branco quente

⊗ Dimerizável



Base: GU10
Bulbo: AR111
Tensão: 127V- 220V (Bivolt)
Temperatura da Cor: 2700K
Frequência: 60Hz
Fator da Potência: >0,7
Corrente Nominal: 0,094A (127V) 0,056A (220V)
Fluxo Luminoso: 950lm
Eficiência Luminosa: 79 lm/W
Ângulo de Abertura: 12°
IRC: RA>80
Vida Útil: 25000h
Temperatura de operação: -20°C -45°C
Tamanho: 74mmx111mm

LÂMPADA AR70

LP220C

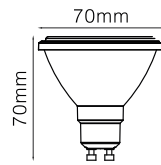

Potência **4,8W**
Equivalência **65W**

2700K - Branco quente

⊗ Dimerizável



Base: GU10
Bulbo: AR70
Tensão: 127V- 220V (Bivolt)
Temperatura da Cor: 2700K
Frequência: 60Hz
Fator da Potência: >0,4
Corrente Nominal: 0,038A (127V) 0,022A (220V)
Fluxo Luminoso: 300lm
Eficiência Luminosa: 63 lm/W
Ângulo de Abertura: 12°
IRC: RA>80
Vida Útil: 25000h
Temperatura de operação: -20°C -45°C
Tamanho: 70mmx70mm

TUBULAR

LP165C

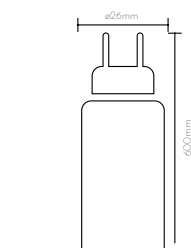

Potência **10W**
Equivalência **26W**

6.500K - Branco frio

⊗ não dimerizável



Base: G13
Bulbo: T8
Tensão: 100V - 240V (bivolt)
Temperatura da Cor: 6.500K
Frequência: 50/60Hz
Fator da Potência: >0,92
Corrente Nominal: 0,077A (127V)
0,049 (220V)
Fluxo Luminoso: 900lm
Eficiência Luminosa: 90lm/W
Ângulo de Abertura: 200°
IRC: >80Ra
Vida Útil: 25.000h
Temperatura de operação: -20°C ~45°C
Tamanho: 26mmx600mm

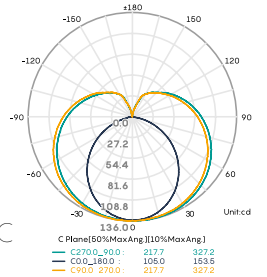

VELA FILAMENTO RETRÔ

LPI71



Potência **2W**
Equivalência **25W**

2.400K - Branco quente

⊗ não dimerizável

Base: E14
Bulbo: B35
Tensão: 100V - 240V (bivolt)
Temperatura da Cor: 2.400K
Frequência: 50/60Hz
Fator da Potência: 0,5
Corrente Nominal: 0,035A
Fluxo Luminoso: 200lm
Eficiência Luminosa: 100lm/W
Ângulo de Abertura: 360°
IRC: 80Ra
Vida Útil: 15.000h
Temperatura de operação: -20°C~45°C
Tamanho: ø35mmX98mm

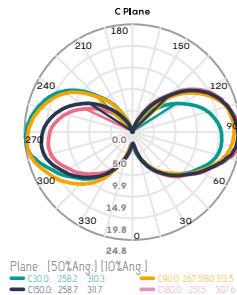
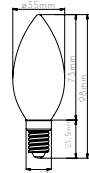

Plane [50%Ang] [10%Ang]
C30: 282 303 C90: 287 303
C0: 287 317 C180: 293 307

luz âmbar

FILAMENTO T32 RETRÔ

LPI67



Potência **2W**
Equivalência **25W**

2.400K - Branco quente

⊗ não dimerizável

Base: E27
Bulbo: T32
Tensão: 100V - 240V (bivolt)
Temperatura da Cor: 2.400K
Frequência: 50/60Hz
Fator da Potência: 0,5
Corrente Nominal: 0,04A
Fluxo Luminoso: 200lm
Eficiência Luminosa: 100lm/W
Ângulo de Abertura: 360°
IRC: 80Ra
Vida Útil: 15.000h
Temperatura de operação: -20°C~45°C
Tamanho: ø32mmX133mm

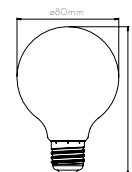

luz âmbar

FILAMENTO T45 RETRÔ

LPI68



Potência **2W**
Equivalência **25W**

2.400K - Branco quente

⊗ não dimerizável

Base: E27
Bulbo: T45
Tensão: 100V - 240V (bivolt)
Temperatura da Cor: 2.400K
Frequência: 50/60Hz
Fator da Potência: 0,5
Corrente Nominal: 0,04A
Fluxo Luminoso: 200lm
Eficiência Luminosa: 100lm/W
Ângulo de Abertura: 360°
IRC: 80Ra
Vida Útil: 15.000h
Temperatura de operação: -20°C~45°C
Tamanho: ø45mmX113mm

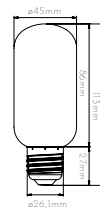

luz âmbar

FILAMENTO G95

LPI83C



Potência **8W**
Equivalência **100W**

2.700K - Branco quente

⊗ não dimerizável

Base: E27
Bulbo: G95
Tensão: 100V - 240V (bivolt)
Temperatura da Cor: 2.700K
Frequência: 50/60Hz
Fator da Potência: 0,7
Corrente Nominal: 0,14A
Fluxo Luminoso: 800lm
Eficiência Luminosa: 100lm/W
Ângulo de Abertura: 360°
IRC: 80Ra
Vida Útil: 15.000h
Temperatura de operação: -20°C~45°C
Tamanho: ø95mmX129mm

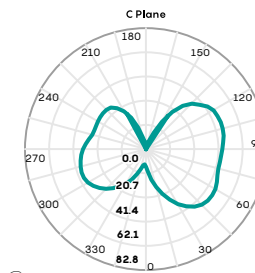
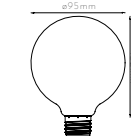

Plane [50%Ang] [10%Ang]
C30: 290 313 C90: 295 313
C0: 290 313 C180: 295 313



FILAMENTO ST58

LPI59C



Potência **4,5W**
Equivalência **35W**

2.700K - Branco quente

⊗ não dimerizável

Base: E27
Bulbo: ST58
Tensão: 100V - 240V (bivolt)
Temperatura da Cor: 2.700K
Frequência: 50/60Hz
Fator da Potência: 80
Corrente Nominal: 0,11A
Fluxo Luminoso: 480lm
Eficiência Luminosa: 106lm/W
Ângulo de Abertura: 360°
IRC: 80Ra
Vida Útil: 25.000h
Temperatura de operação: -20°C~45°C
Tamanho: ø58mmX130mm

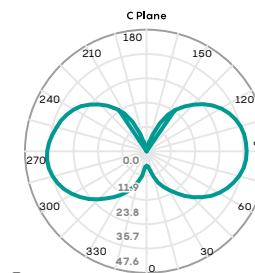
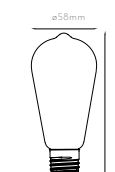

Plane [50%Ang] [10%Ang]
C30: 292 322 C90: 297 322
C0: 292 322 C180: 297 322



FITA DE LED 14,4W/m

LP222



3000K - Branco quente

✂ - - - a cada 50cm

Dimerizável

Tensão: **127V**

Potência total: 360W

Potência por metro: 14,4W/m

Tipo de Led: SMD5050

Fluxo luminoso total: 13750lm

Fluxo luminoso/m: 550lm/m

Quantidade de led/metro: 60

IRC (Ra):>70

Grau de proteção:IP67

Vida útil: 25.000h

Fator de potência: FP>0,7

Acessórios indicados:

LP243 dimer com controle remoto 127V

IP67

pronto
para uso

25 metros

FITA DE LED 13,2W/m

LP223



3000K - Branco quente

✂ - - - a cada 50cm

Dimerizável

Tensão: **220V**

Potência total: 330W

Potência por metro:13,2W/m

Tipo de Led: SMD5050

Fluxo luminoso total:13750lm

Fluxo luminoso/m: 550lm/m

Quantidade de led/metro:60

IRC (Ra):>70

Grau de proteção:IP67

Vida útil: 25.000h

Fator de potência:FP>0,7

Acessórios indicados:

LP244 dimer com controle remoto 220V

IP67

pronto
para uso

25 metros

FITA DE LED 4,8W/m

LPO50



3000K - Branco QUENTE

✂ - - - a cada 50cm

Dimerizável

Tensão: **127VDC**

Potência total: 24W

Potência por metro: 4,8W/m

Fluxo luminoso total: 1100lm

Fluxo luminoso/m: 220lm/m

Quantidade de led/metro:60

IRC (Ra):>80

Grau de proteção:IP67

Vida útil: 25.000

Acessórios indicados:

LPO99B Kit

LPO89 Terminal

LPO87 Braçadeira

IP67

pronto
para uso

5 metros

FITA DE LED 4,8W/m

LPO52



2700K - Branco quente

✂ - - - a cada 3 Leds

Dimerizável

Tensão: **220V**

Potência total: 24W

Potência por metro: 4,8W/m

Fluxo luminoso total: 1100lm

Fluxo luminoso/m: 220lm/m

Quantidade de led/metro:60

IRC (Ra):>80

Grau de proteção:IP67

Vida útil: 25.000

Acessórios indicados:

LPO99B Kit

LPO89 Terminal

LPO87 Braçadeira

IP67

pronto
para uso

5 metros

FITA DE LED 5W/m

LP224



2700K - Branco quente

✂ - - - a cada 5cm

Dimerizável

Tensão: **12VDC**

Potência total: 25W

Potência por metro:5W/m

Tipo de Led: SMD2835

Fluxo luminoso total: 2250lm

Fluxo luminoso/m: 450lm/m

Quantidade de led/metro:60

IRC (Ra):>80

Grau de proteção:IP20

Vida útil: 25.000

LP236 - driver30W 12V 127V-220V 2,5A

LP237 - driver 60W 12V 127V-220V 5A

LP238 - driver 60W 12V dim. 127V 5A

LP238B - driver 60W 12V dim. 220V 5A

LP239 -driver 100W 12V dim. 127V 8,3A

LP239B - driver 100W 12V dim. 220V 8,3A

LP240 - controle remoto dimer 12V 6A

IP20

5 metros

FITA DE LED 5W/m

LP225



2700K - Branco quente

✂ - - - a cada 5cm

Dimerizável

Tensão: **12VDC**

Potência total: 25W

Potência por metro:5W/m

Tipo de Led: SMD2835

Fluxo luminoso total: 1750lm

Fluxo luminoso/m: 350lm/m

Quantidade de led/metro:60

IRC (Ra):>80

Grau de proteção:IP65

Vida útil: 25.000

LP236 - driver30W 12V 127V-220V 2,5A

LP237 - driver 60W 12V 127V-220V 5A

LP238 - driver 60W 12V dim. 127V 5A

LP238B - driver 60W 12V dim. 220V 5A

LP239 -driver 100W 12V dim. 127V 8,3A

LP239B - driver 100W 12V dim. 220V 8,3A

LP240 - controle remoto dimer 12V 6A

IP65

5 metros

FITA DE LED 5W/m

LP226



4000K - Branco neutro



✂ - - - a cada 5cm

Dimerizável

Tensão: **12VDC**

Potência total: 25W

Potência por metro: 5W/m

Tipo de Led: SMD2835

Fluxo luminoso total: 2250lm

Fluxo luminoso/m: 450lm/m

Quantidade de led/metro: 60

IRC (Ra): >80

Grau de proteção: IP20

Vida útil: 25.000

LP236 - driver 30W 12V 127V-220V 2,5A
 LP237 - driver 60W 12V 127V-220V 5A
 LP238 - driver 60W 12V dim. 127V 5A
 LP238B - driver 60W 12V dim. 220V 5A
 LP239 - driver 100W 12V dim. 127V 8,3A
 LP239B - driver 100W 12V dim. 220V 8,3A
 LP240 - controle remoto dimer 12V 6A

IP20

5 metros

FITA DE LED 5W/m

LP227



4000K - Branco neutro



✂ - - - a cada 5cm

Dimerizável

Tensão: **12VDC**

Potência total: 25W

Potência por metro: 5W/m

Tipo de Led: SMD2835

Fluxo luminoso total: 1750lm

Fluxo luminoso/m: 350lm/m

Quantidade de led/metro: 60

IRC (Ra): >80

Grau de proteção: IP65

Vida útil: 25.000

LP236 - driver 30W 12V 127V-220V 2,5A
 LP237 - driver 60W 12V 127V-220V 5A
 LP238 - driver 60W 12V dim. 127V 5A
 LP238B - driver 60W 12V dim. 220V 5A
 LP239 - driver 100W 12V dim. 127V 8,3A
 LP239B - driver 100W 12V dim. 220V 8,3A
 LP240 - controle remoto dimer 12V 6A

IP65

5 metros

FITA DE LED 10W/m

LP228



2700K - Branco quente



✂ - - - a cada 5cm

Dimerizável

Tensão: **12VDC**

Potência total: 50W

Potência por metro: 10W/m

Tipo de Led: SMD5050

Fluxo luminoso total: 3500lm

Fluxo luminoso/m: 700lm/m

Quantidade de led/metro: 60

IRC (Ra): >80

Grau de proteção: IP20

Vida útil: 25.000

LP236 - driver 30W 12V 127V-220V 2,5A
 LP237 - driver 60W 12V 127V-220V 5A
 LP238 - driver 60W 12V dim. 127V 5A
 LP238B - driver 60W 12V dim. 220V 5A
 LP239 - driver 100W 12V dim. 127V 8,3A
 LP239B - driver 100W 12V dim. 220V 8,3A
 LP240 - controle remoto dimer 12V 6A

IP20

5 metros

FITA DE LED 10W/m

LP229



2700K - Branco quente



✂ - - - a cada 5cm

Dimerizável

Tensão: **12VDC**

Potência total: 50W

Potência por metro: 10W/m

Tipo de Led: SMD5050

Fluxo luminoso total: 3750lm

Fluxo luminoso/m: 550lm/m

Quantidade de led/metro: 60

IRC (Ra): >80

Grau de proteção: IP65

Vida útil: 25.000

LP236 - driver 30W 12V 127V-220V 2,5A
 LP237 - driver 60W 12V 127V-220V 5A
 LP238 - driver 60W 12V dim. 127V 5A
 LP238B - driver 60W 12V dim. 220V 5A
 LP239 - driver 100W 12V dim. 127V 8,3A
 LP239B - driver 100W 12V dim. 220V 8,3A
 LP240 - controle remoto dimer 12V 6A

IP65

5 metros

FITA DE LED 10W/m

LP230



4000K - Branco neutro



✂ - - - a cada 5cm

Dimerizável

Tensão: **12VDC**

Potência total: 50W

Potência por metro: 10W/m

Tipo de Led: SMD5050

Fluxo luminoso total: 3500lm

Fluxo luminoso/m: 700lm/m

Quantidade de led/metro: 60

IRC (Ra): >80

Grau de proteção: IP20

Vida útil: 25.000

LP236 - driver 30W 12V 127V-220V 2,5A
 LP237 - driver 60W 12V 127V-220V 5A
 LP238 - driver 60W 12V dim. 127V 5A
 LP238B - driver 60W 12V dim. 220V 5A
 LP239 - driver 100W 12V dim. 127V 8,3A
 LP239B - driver 100W 12V dim. 220V 8,3A
 LP240 - controle remoto dimer 12V 6A

IP20

5 metros

FITA DE LED 10W/m

LP231



4000K - Branco neutro



✂ - - - a cada 5cm

Dimerizável

Tensão: **12VDC**

Potência total: 50W

Potência por metro: 10W/m

Tipo de Led: SMD5050

Fluxo luminoso total: 2750lm

Fluxo luminoso/m: 550lm/m

Quantidade de led/metro: 60

IRC (Ra): >80

Grau de proteção: IP65

Vida útil: 25.000

LP236 - driver 30W 12V 127V-220V 2,5A
 LP237 - driver 60W 12V 127V-220V 5A
 LP238 - driver 60W 12V dim. 127V 5A
 LP238B - driver 60W 12V dim. 220V 5A
 LP239 - driver 100W 12V dim. 127V 8,3A
 LP239B - driver 100W 12V dim. 220V 8,3A
 LP240 - controle remoto dimer 12V 6A

IP65

5 metros

FITA DE LED 16W/m

LP232



2700K - Branco quente

✂ - - - a cada 5cm

Dimerizável

Tensão: **24VDC**

Potência total: 80W

Potência por metro: 16W/m

Tipo de Led: SMD2835

Fluxo luminoso total: 5500lm

Fluxo luminoso/m: 1100lm/m

Quantidade de led/metro: 120

IRC (Ra): >90

Grau de proteção: IP20

Vida útil: 25.000

Acessórios indicados:

LP241- Driver 100W 24V dim. 127V 4,16A

LP241B - Driver 100W 24V dim. 220V 4,16A

LP242 - Controle remoto dimer 24V 6A

IP20

IRC(Ra)>90

5 metros

FITA DE LED 16W/m

LP233



4000K - Branco neutro

✂ - - - a cada 5cm

Dimerizável

Tensão: **24VDC**

Potência total: 80W

Potência por metro: 16W/m

Tipo de Led: SMD2835

Fluxo luminoso total: 5500lm

Fluxo luminoso/m: 1100lm/m

Quantidade de led/metro: 120

IRC (Ra): >90

Grau de proteção: IP20

Vida útil: 25.000

Acessórios indicados:

LP241- Driver 100W 24V dim. 127V 4,16A

LP241B - Driver 100W 24V dim. 220V 4,16A

LP242 - Controle remoto dimer 24V 6A

IP20

IRC(Ra)>90

5 metros

FITA DE LED 19W/m

LP234



2700K - Branco quente

✂ - - - a cada 5cm

Dimerizável

Tensão: **24VDC**

Potência total: 95W

Potência por metro: 19W/m

Tipo de Led: SMD2835

Fluxo luminoso total: 8000lm

Fluxo luminoso/m: 1600lm/m

Quantidade de led/metro: 240

IRC (Ra): >90

Grau de proteção: IP20

Vida útil: 25.000

Acessórios indicados:

LP241- Driver 100W 24V dim. 127V 4,16A

LP241B - Driver 100W 24V dim. 220V 4,16A

LP242 - Controle remoto dimer 24V 6A

IP20

IRC(Ra)>90

5 metros

FITA DE LED 19W/m

LP235



4000K - Branco neutro

✂ - - - a cada 5cm

Dimerizável

Tensão: **24VDC**

Potência total: 95W

Potência por metro: 19W/m

Tipo de Led: SMD2835

Fluxo luminoso total: 8000lm

Fluxo luminoso/m: 1600lm/m

Quantidade de led/metro: 240

IRC (Ra): >90

Grau de proteção: IP20

Vida útil: 25.000

Acessórios indicados:

LP241- Driver 100W 24V dim. 127V 4,16A

LP241B - Driver 100W 24V dim. 220V 4,16A

LP242 - Controle remoto dimer 24V 6A

IP20

IRC(Ra)>90

5 metros

DRIVER 12VDC 30W - BIVOLT

LP236



Não Dimerizável

Tensão saída: **12VDC**

Tensão entrada: 127V / 220V (Bivolt)

Potência: 30W

Corrente: 2,5A

Grau de proteção: IP20

DRIVER 12VDC 60W - BIVOLT

LP237



Não Dimerizável

Tensão saída: **12VDC**

Tensão entrada: 127V / 220V (Bivolt)

Potência: 60W

Corrente: 5A

Grau de proteção: IP20

DRIVER 12VDC 60W 127V DIMERIZÁVEL

LP238



 Dimerizável

Tensão saída: **12VDC**
Tensão entrada: 127V
Potência: 60W
Corrente: 5A
Grau de proteção: IP20



DRIVER 12VDC 60W 220V DIMERIZÁVEL

LP238B



 Dimerizável

Tensão saída: **12VDC**
Tensão entrada: 220V
Potência: 60W
Corrente: 5A
Grau de proteção: IP20



DRIVER 12VDC 100W 127V DIMERIZÁVEL

LP239



 Dimerizável

Tensão saída: **12VDC**
Tensão entrada: 127V
Potência: 100W
Corrente: 8,3A
Grau de proteção: IP20



DRIVER 12VDC 100W 220V DIMERIZÁVEL

LP239B



 Dimerizável

Tensão saída: **12VDC**
Tensão entrada: 220V
Potência: 100W
Corrente: 8,3A
Grau de proteção: IP20



DRIVER 24VDC 100W 127V DIMERIZÁVEL

LP241



 Dimerizável

Tensão saída: **24VDC**
Tensão entrada: 127V
Potência: 100W
Corrente: 4,16A
Grau de proteção: IP20



DRIVER 24VDC 100W 200V DIMERIZÁVEL

LP241B



 Dimerizável

Tensão saída: **24VDC**
Tensão entrada: 220V
Potência: 100W
Corrente: 4,16A
Grau de proteção: IP20



DRIVER 12 VDC 100W - BIVOLT

LP081



⚠ Não Dimerizável

Tensão de saída: **12 VDC**
Tensão entrada: 127V / 220V (Bivolt)
Potência: 100W
Corrente: 8,5A
Potência total: 100W



DIMER COM CONTROLE PARA FITA DE LED 12VDC

LP240



Tensão saída: 12VDC
Tensão entrada 127V - 220V (Bivolt)
Corrente: 6A
Grau de proteção IP20
Potência máxima: 72W



DIMER COM CONTROLE PARA FITA DE LED 24VDC

LP242



Tensão saída: 24VDC
Tensão entrada 127V - 220V (Bivolt)
Corrente: 6A
Grau de proteção IP20
Potência máxima: 144W



DIMER COM CONTROLE REMOTO PARA FITA 127V

LP243



Tensão: 127V
Corrente: 3,9A
Grau de proteção: IP20
Potência máxima: 500W



DIMER COM CONTROLE REMOTO PARA FITA 220V

LP244



Tensão: 220V
Corrente: 4,5A
Grau de proteção: IP20
Potência máxima: 1000W



BRAÇADEIRA PARA FITAS DE LED 127V-220V

LP087



Medida: 3cm x 0,5cm x 0,5cm
Potência total: 4,8W

Acessórios indicados:

Recomentado para fita de led LPO50 e LPO52



BRAÇADEIRA PARA FITAS DE LED 127V-220V

LPO88



Medida: 3,5cm x 0,5cm x 0,5cm

Acessórios indicados:

Recomentado para fita de led LP222 e LP223



TERMINAL PARA FITA DE LED 127V - 220V

LPO89



Medida: 1cm x 1cm x 1cm

Acessórios indicados:

Recomentado para fita de led LPO50 e LPO52



TERMINAL PARA FITA DE LED 127V - 220V

LPO90



Medida: 2cm x 2cm x 1cm

Acessórios indicados:

Recomentado para fita de led LP222 e LP223



CONECTOR PARA FITA DE LED

LPO92



Medida: 2cm x 3cm x 1cm

Acessórios indicados:

Recomentado para fita de led LP222 e LP223



ALIMENTADOR PARA FITA DE LED

LPO97



Medida: 57cm

Acessórios indicados:

Recomentado para fita de led LP222 e LP223



KIT DE ACESSÓRIOS PARA FITA DE LED 127V - 127V

LPO99



Medida: 53cm

Acessórios indicados:

Recomentado para fita de led LPO50 e LPO52



KIT DE ACESSÓRIOS PARA FITA DE LED 220V

LP099B



Medida: 53cm

Acessórios indicados:

Recomentado para fita de led
LP222 e LP223



EMENDA PARA FITA DE LED 12V



Tensão: 12V
Medida: 1cm x 1,5cm x 1,5cm
Potência total: 4,8/9,6W/m

Acessórios indicados:

Indicado para fita de led LP224 até
LP227



ADAPTADOR PARA SOQUETE E14/GU10

LP111



Medida: ø3cm x 5cm
Soquete: E14/GU10
Tipo: E14/GU10



ADAPTADOR PARA SOQUETE E27/G9

LP115



Medida: ø2cm x 4cm
Soquete: E27/G9



códigos

AC002	274	DLO25P	361	DL146PAR30W	343	DY001S	213
AF001	275	DLO26B	360	DL147AR	344	DY002	212
AQ004S	211	DLO26P	361	DL147DIC	344	EA008	332
AQ008L	206	DLO27B	362	DL147PAR	344	ESPELHO	319
AQ008LA	206	DLO27P	363	DL148B	364	EX78BBR	339
AQ009	207	DLO28B	362	DL148W	364	EX78BPT	338
AQ009A	207	DLO30B	353	DL149B	364	EX596BR	339
AQ009M	207	DLO30P	353	DL149W	364	EX76OBR	339
AQ009MA	207	DLO31P	353	DL150	366	EX76OPT	339
AQ024L	199	DLO32B	352	DL151	366	EX1315BR	335
AQ024S	199	DLO32P	352	DL153B	366	EX1315PT	335
AQ025M	201	DLO34B	356	DL153W	366	EX1600	335
AQ026L	199	DLO34P	356	DL154B	365	EX160OPT	335
AQ028L	197	DLO36B	356	DL154W	365	EX1684BR	336
AQ028S	197	DLO36P	356	DL155W	358	EX1684PT	336
AQ029	270	DLO38BG	357	DL156B	358	EX2011BR	336
AQ030C	201	DLO38PG	357	DL156W	358	EX2011PT	336
AQ030G	201	DLO40B	357	DL180EQ	369	EX2014BR	337
AQ031C	200	DLO40P	357	DL180SF	369	EX2014PT	337
AQ031G	200	DLO44B	354	DL180SQ	369	EX2064	337
BB014	237	DLO44P	354	DL240EF	370	EX2064PT	337
BB023	7	DLO46B	354	DL240EQ	370	EX2219	338
BB024	6	DLO46P	354	DL240SF	370	EX2219PT	338
BB025	7	DLO48BG	355	DL240SQ	370	EX2451BR	338
BD005	10	DLO48PG	355	DL300EF	371	EX2451PT	338
BD006	11	DLO50B	355	DL300EQ	371	EY001	270
BD007	11	DLO50P	355	DL300SF	371	FH015A	283
BK5308	195	DL142BR	372	DL300SQ	371	FO006A	244
BK5318	195	DL143B5	350	DLD006N	367	FO006S	244
BO013L	229	DL143B5N	350	DLD006Q	367	FO026LB	33
BO013S	229	DL143B10	350	DLD012N	367	FO026LW	33
BW1308B	196	DL143B10N	350	DLD012Q	367	FO026SB	32
BW1308C	196	DL143P5	351	DLD018N	368	FO026SW	32
CI008A	311	DL143P10	351	DLD018Q	368	GA011	211
CL0100	329	DL143P10N	351	DLD024Q	368	GA014	211
DA004	256	DL145B	365	DS001	12	GD001NK	48
DG001	222	DL145W	365	DS002	13	GD002NK	49
DG002	222	DL146AR70B	342	DS003	13	GD003NK	49
DL14P5N	351	DL146AR70W	343	DW001	14	GD004	52
DLO19BT	359	DL146AR111B	342	DW002	81	GD005	53
DLO19PT	359	DL146AR111W	343	DW003	88	GD006	53
DLO20BT	359	DL146DICB	342	DW004	89	GD007LB	35
DLO20PT	359	DL146DICW	343	DW005LB	15	GD007LW	35
DLO22B	362	DL146MDB	342	DW005LG	16	GD007SB	34
DLO22P	363	DL146MDW	343	DW005SB	17	GD007SW	34
DLO23B	360	DL146PAR20B		DW005SG	17	GD008	55
DLO23P	361		342	DW006B	19	GD009	55
DLO24B	360	DL146PAR20W		DW006G	19	GD010B	37
DLO24P	361		343	DW007	95	GD010G	37
DLO25B	360	DL146PAR30B	342	DY001L	213	GD010W	36

GD011LB	38	HC018	56	HO7613AM	263	HU4003A	292	LI2248C	310	LP239B	387	MM002	233	OC022	72
GD011LW	38	HC019	57	HO7613CO	263	HU4003B	292	LPO50	380	LP240	388	MO0016	111	OD029C	215
GD011SB	39	HLO01	271	HO7616AM	263	HU4003C	292	LPO52	381	LP241	387	MO0016E	111	OD037SL	250
GD011SW	39	HLO02	271	HO7616CO	263	HU5001A	293	LPO81	388	LP241B	387	MO0016G	110	OD037SM	250
GD012LB	42	HLO03B	99	HO7616CR	263	HU5001B	293	LPO87	389	LP242	388	MRO07	216	OD037SS	250
GD012LW	42	HLO03G	99	HP001	221	HU5001C	293	LPO88	390	LP243	389	MRO07	216	OD038EL	251
GD012SB	40	HLO03W	97	HP002	221	HU5001W	293	LPO89	390	LP244	389	MRO08	216	OD038EM	251
GD012SW	41	HLO04B	98	HP003	226	HU6422P	262	LPO90	390	LU001T	310	L180EF	369	OD038ES	251
GD013B	43	HLO04G	98	HP004	226	ID001	294	LPO92	391	LU006A	330	NS5101B	349	OD039G	243
GD013W	43	HLO04W	97	HU021	334	JF015A	192	LPO97	391	ME001	287	NS5201B	349	OD039R	243
GD014B	44	HLO05	247	HU022	334	JF015C	194	LPO99	391	ME002	287	NS5601B	349	OD040	237
GD014W	44	HLO06	247	HU023	334	JF018A	192	LPO99B	392	ME003	286	NS5701B	349	OP027	282
GD015B	46	HLO07	246	HU024	334	JF018C	194	LP111	392	ME004	287	NS7000B	345	OP049TS	328
GD015W	46	HLO08M	101	HU051B	334	JF028S	193	LP115	393	ME005	287	NS7000P	346	OP056	253
GD016B	47	HLO08S	101	HU051S	334	JF112A	193	LP159C	379	MIO01	315	NS7001B	347	OP056G	252
GD016W	47	HLO09	217	HU1002A	289	JF112C	194	LP165C	377	MIO02	316	NS7001P	348	OP056R	252
GL001EB	324	HLO10	217	HU1002B	289	JF118A	193	LP167	378	MIO03	316	NS7110B	345	OP058A	297
GL001EW	324	HLO11M	218	HU1002C	289	JF118C	194	LP168	378	MIO04	317	NS7110P	346	OP058B	297
GL001GB	324	HLO11S	219	HU1002W	289	JF305	198	LP171	378	MIO05	316	NS7111B	347	OP058C	297
GL001GW	324	HLO12M	230	HU1100	204	JF308	198	LP183C	379	MIO06	312	NS7111P	348	OP060CH	245
GL002E	322	HLO12S	231	HU1100A	204	JF312	198	LP201C	375	MIO07	314	NS7200B	345	OP060S	245
GL002G	322	HLO13	231	HU1101	204	JO001C	244	LP202C	376	MIO08	314	NS7200P	346	OP8617	294
GL003E	322	HLO14	97	HU1101A	204	JO001G	244	LP213C	374	MIO09	313	NS7201B	347	PD001AM	259
GL003G	322	HLO14B	96	HU1102	204	JO004	60	LP214C	374	MIO10	313	NS7201P	348	PD001CO	259
GL004E	323	HLO14G	96	HU1102A	204	JO004NK	59	LP215C	374	MIO11	314	NS7300B	345	PD001CR	259
GL004G	323	HLO15	219	HU1103	203	JO005	60	LP216C	375	MIO12	315	NS7300P	346	PD002AM	260
GL005E	328	HLO16	100	HU1103A	203	JO005NK	58	LP217C	375	MIO13	317	NS7301B	347	PD002CO	260
GL005G	328	HLO17LB	103	HU1104	203	JU006	62	LP218C	376	MLO01B	279	NS7301P	348	PD002CR	260
GL006E	331	HLO17LW	102	HU1104A	203	JU007	63	LP219C	377	MLO01G	279	NS7350B	345	PD005AM	261
GL006G	331	HLO17SB	104	HU2105	202	JU008	63	LP220C	376	MLO01W	279	NS7350P	346	PD005CO	261
GL007E	331	HLO17SW	104	HU2105A	202	JY010	281	LP221C	377	MLO02B	278	NS7351B	347	PD005CR	261
GL007G	331	HLO18	105	HU2106	208	KB001A	265	LP222	380	MLO02W	278	NS7351P	348	PD006AM	258
GL008	321	HLO19	105	HU2106A	208	KB001C	265	LP223	380	MLO07B	279	NS7700B	345	PD006CO	258
GL009	321	HM001	220	HU2107	208	KB002A	265	LP224	381	MLO07W	279	NS7700P	346	PD006CR	258
GL010C	319	HM002	220	HU2107A	208	KB002C	265	LP225	381	MLO08B	303	NS7701B	347	PD007AM	262
GL010G	319	HM006CR	27	HU2149P	215	KD1939	304	LP226	382	MLO08W	303	NS7701P	348	PD007CO	262
GL011	320	HM006WB	27	HU2157	205	KW002B	24	LP227	382	MLO10B	303	OC003	200	PD007CR	262
GRO01	229	HM007WB	26	HU2157A	205	KW004G	24	LP228	382	MLO10W	303	OC010	68	PD009L	214
GX008	210	HM008CR	28	HU2161	205	KY001L	255	LP229	383	MLO12	280	OC011L	67	PD009S	214
GX008SC	210	HM008WB	28	HU2161A	205	KY001LG	255	LP230	383	MLO13	280	OC011S	66	PD018L	245
HB820	311	HM009CR	29	HU2173	209	KY001M	255	LP231	383	MLO14	280	OC012	67	PD018S	245
HC006	238	HM009WB	29	HU2173A	209	KY001MG	255	LP232	384	MLO15B	23	OC013	68	QT001E	228
HC007L	239	HM010CR	31	HU2174A	209	KY001S	254	LP233	384	MLO15GB	21	OC014	71	QT001G	228
HC007S	238	HM010WB	30	HU3002A	290	KY001SG	254	LP234	384	MLO15GW	21	OC015	70	RE009	273
HC012	232	HO027	306	HU3002B	290	LB001	285	LP235	385	MLO15W	22	OC016	71	RE010L	225
HC013	232	HO028	306	HU3002C	290	LB002	285	LP236	385	MLO16B	23	OC017	61	RE010S	224
HC014	241	HO110A	306	HU3002W	290	LB003	285	LP237	385	MLO16GB	20	OC018	61	RE011	224
HC015	241	HO110B	306	HU4002A	291	LB004	284	LP238	386	MLO16GW	20	OC019	69	RE012	242
HC016	240	HO1370B	273	HU4002B	291	LB005	284	LP238B	386	MLO16W	22	OC020	69	RE013	242
HC017	56	HO7613	263	HU4002C	291	LB008	285	LP239	386	MM001	233	OC021	72	RE014L	227

RE014S	227	TRO01B	86	YD756A	308
RE017L	236	TRO02	87	ZD2727	305
RE017S	236	TRO02B	86	ZD2859	305
RM001B	268	TRO03	92	ZU009A	304
RM001R	269	TRO03B	91	ZU009B	304
RM002B	268	TRO04	93		
RM002R	269	TRO04B	91		
RM003B	267	TRO05	93		
RM003G	266	TRO05B	90		
RM004B	267	TRO06	79		
RM004G	266	TRO06B	79		
RM005B	253	TRO07	94		
RM005G	253	VT2041W	307		
RM005R	253	VT2070	304		
RZ001EL	107	WN007	272		
RZ001ES	107	WR001	314		
RZ001ESB	108	WR002	318		
RZ001L	107	WR003	318		
RZ001S	107	WR004	318		
RZ001SB	108	WR005	318		
RZ002	257	XL1115	326		
RZ003	109	XL1121	326		
RZ003G	106	XL1151	326		
RZ004	109	XL1152	327		
RZ004G	106	XL1155	327		
RZ005	248	XL1205	325		
RZ006	249	XL1206	325		
RZ007	248	XL1210	326		
SE8961A	283	XL1338	327		
SQ001	76	XL1339	327		
SQ001B	74	XL1346	325		
SQ002	77	XL8204	325		
SQ002B	73	XN001	277		
SQ003	77	XN002	277		
SQ003B	75	XN003	277		
SQ004	78	XN004	276		
SQ004B	74	XN005	277		
SQ005	78	XN006G	288		
SQ005B	75	XN008G	288		
SQ006	84	YD001	235		
SQ006B	83	YD003	235		
SQ007	84	YD004	234		
SQ007B	82	YD005	235		
SQ008	85	YD006	272		
SQ008B	83	YD011	223		
SQ009	80	YD012	234		
SQ010	80	YD101	308		
DLO28P	363	YD134	307		
TE0127	329	YD604	307		
TRO01	87	YD631A	308		

Acompanhe
a Bella



@bellailuminacao



/bellailuminacao



Bella Iluminação



/bellailuminacao



www.bellailuminacao.com.br